

AASHTOWare BrDR 7.5.0

Truss Tutorial

T1 – Truss Floorbeam Stringer Example

T1 – Truss Floorbeam Stringer Example

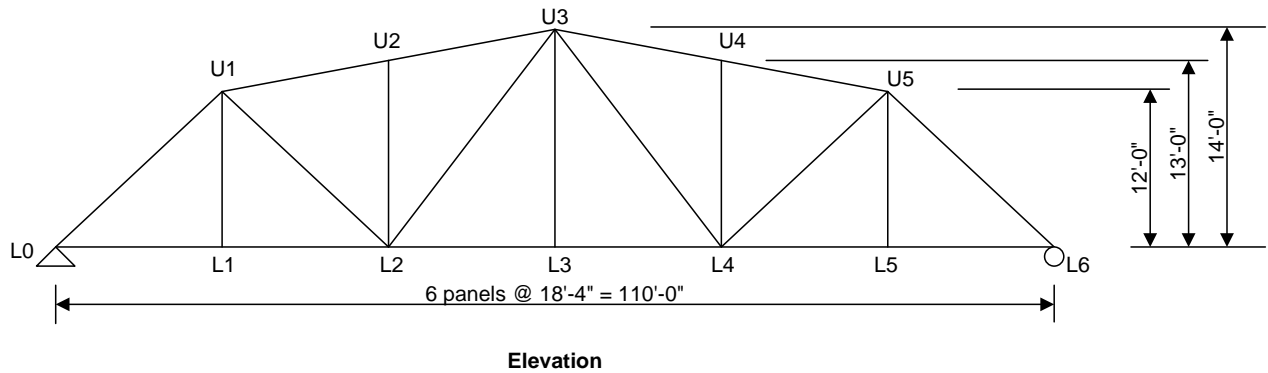
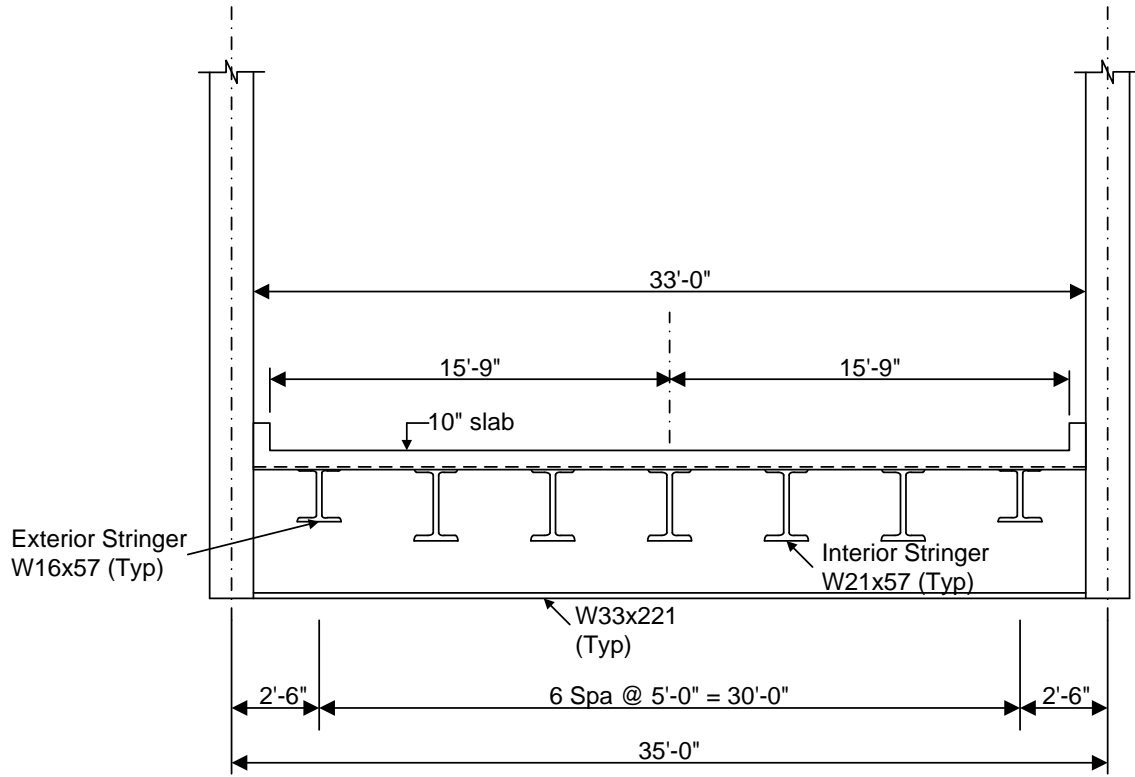

T1 – Truss Floorbeam Stringer Example

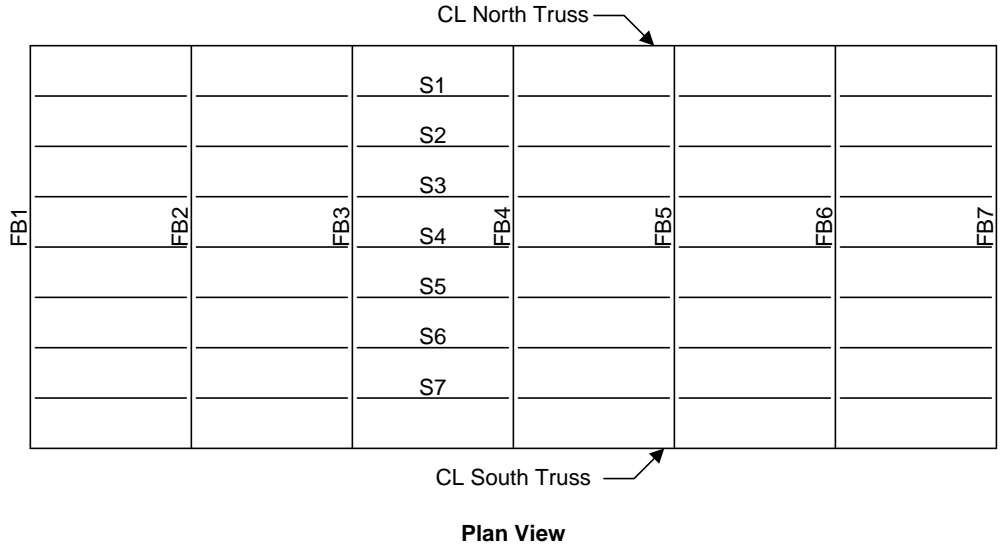

Truss Live Load Distribution Factors

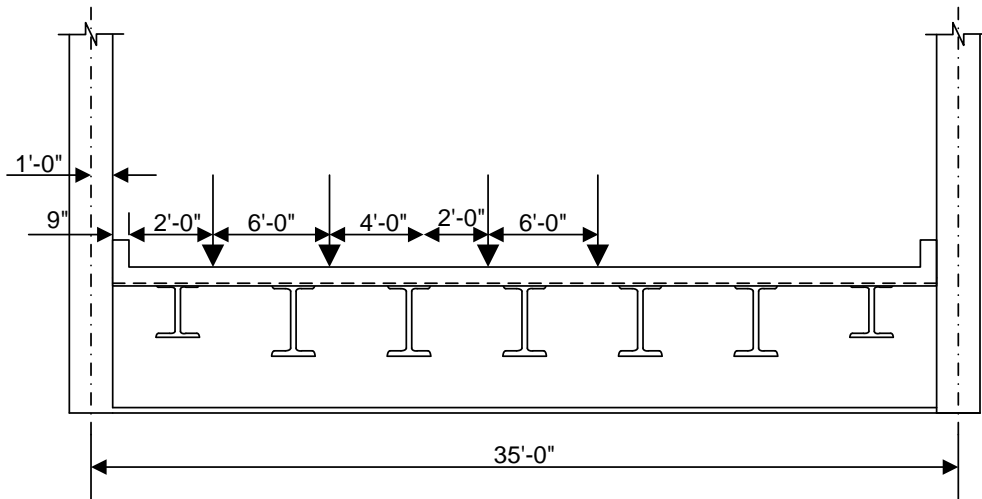

Force

1 Lane DF = $(31.25 + 25.25)/35 = 1.61$ wheels

Multi Lane DF = $(31.25 + 25.25 + 19.25 + 13.25)/35 = 2.54$ wheels

Deflection

1 Lane DF = $2 \text{ wheels} / 2 \text{ trusses} = 1.0$ wheels

Multi Lane DF = $4 \text{ wheels} / 2 \text{ trusses} = 2.0$ wheels

T1 – Truss Floorbeam Stringer Example

2. TRUSS MEMBERS

- i. L₀L₁
L₁L₂
L₄L₅
L₅L₆

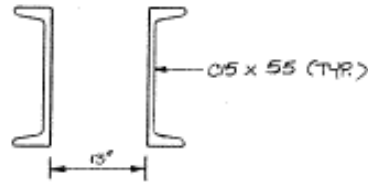

$$A = 2(16.16) = 32.32 \text{ in}^2$$

- ii. L₂L₃
L₃L₄

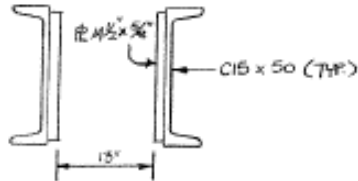

$$A = 2 \left[14.69 + 4 \left(\frac{3}{8} \right) \right] = 47.51 \text{ in}^2$$

- iii. L₁L₆
L₂L₅
L₃L₄
L₄L₅
L₅L₆

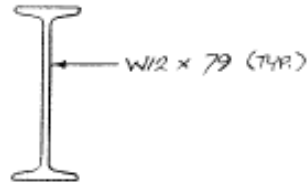

$$A = 23.22 \text{ in}^2$$

- iv. L₀L₁
L₆L₇

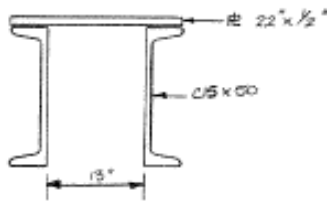

$$A = 2(14.69) + (22 \times \frac{1}{2}) = 40.38 \text{ in}^2$$

- v. L₁L₂
L₂L₃
L₅L₆
L₆L₇

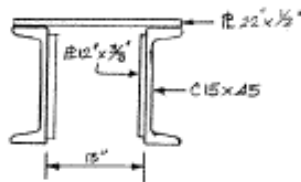

$$A = 2 \left[13.22 + 12 \left(\frac{3}{8} \right) \right] + (22 \times \frac{1}{2}) = 46.44 \text{ in}^2$$

- vi. L₁L₂
L₂L₃
L₃L₄
L₄L₅



$$A = 19.1 \text{ in}^2$$

T1 – Truss Floorbeam Stringer Example

BrDR Tutorial

This example describes entering a truss-floorbeam-stringer system and performing a rating of the truss.

Topics Covered

- Truss description and analysis.
- Truss-floorbeam-stringer system superstructure.
- Truss line superstructures.

Truss description and analysis

Trusses are described in **BrDR** by entering a text description of the truss in the **BrDR** Truss Command Language. This language contains commands to describe the truss geometry, members, loads, etc. The **Truss Command Language User Manual** can be accessed from the **Help** menu in BrDR as described below.

First from the **Bridge Explorer** create a **New** bridge and enter the following description data.

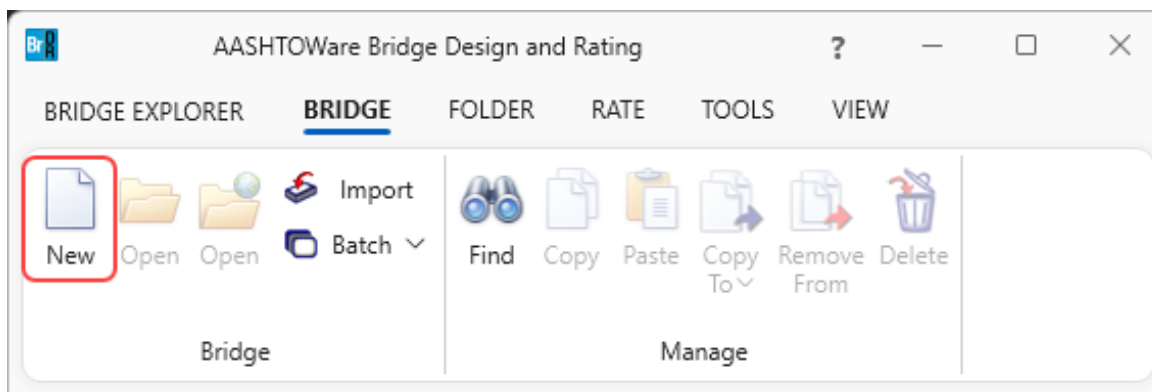

T1 – Truss Floorbeam Stringer Example

Bridge ID: NBI structure ID (8):

Template
 Bridge completely defined

Bridge Workspace View
 Superstructures
 Culverts
 Substructures

Description | Description (cont'd) | Alternatives | Global reference point | Traffic | Custom agency fields

Name: Year built:

Description:

Location: Length: ft

Facility carried (7): Route number:

Feat. intersected (6): Mi. post:

Default units:

Bridge association... BrR BrD BrM

OK Apply Cancel

Click **OK** to apply the data and close the window.

Click on the **Bridge Workspace** ribbon to access the **Support** menu and click on the **Help** button as shown below.

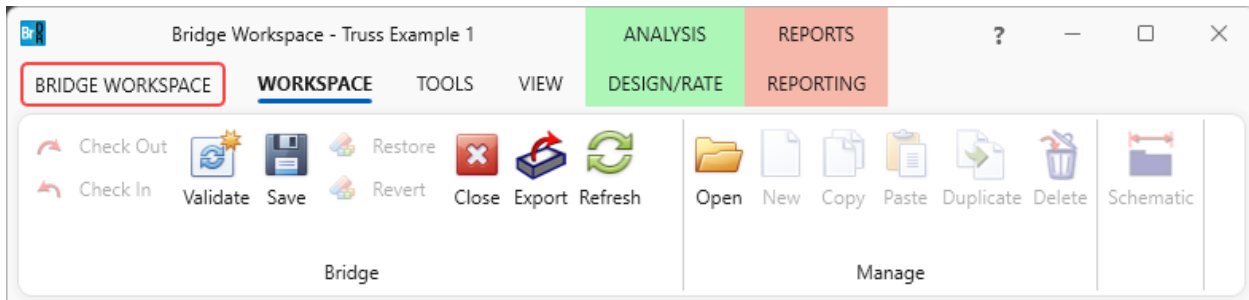

T1 – Truss Floorbeam Stringer Example

In the **Engine Help** column select either **AASHTO Truss LFR** or **AASHTO Truss LRFR** to access the **Truss Input Command Manual** and **Truss Method of Solution** for the selected engine. Double-click on **Truss Input Command Manual** from the **Engine Help Configuration** column to open the truss input command manual for the selected engine as shown below.

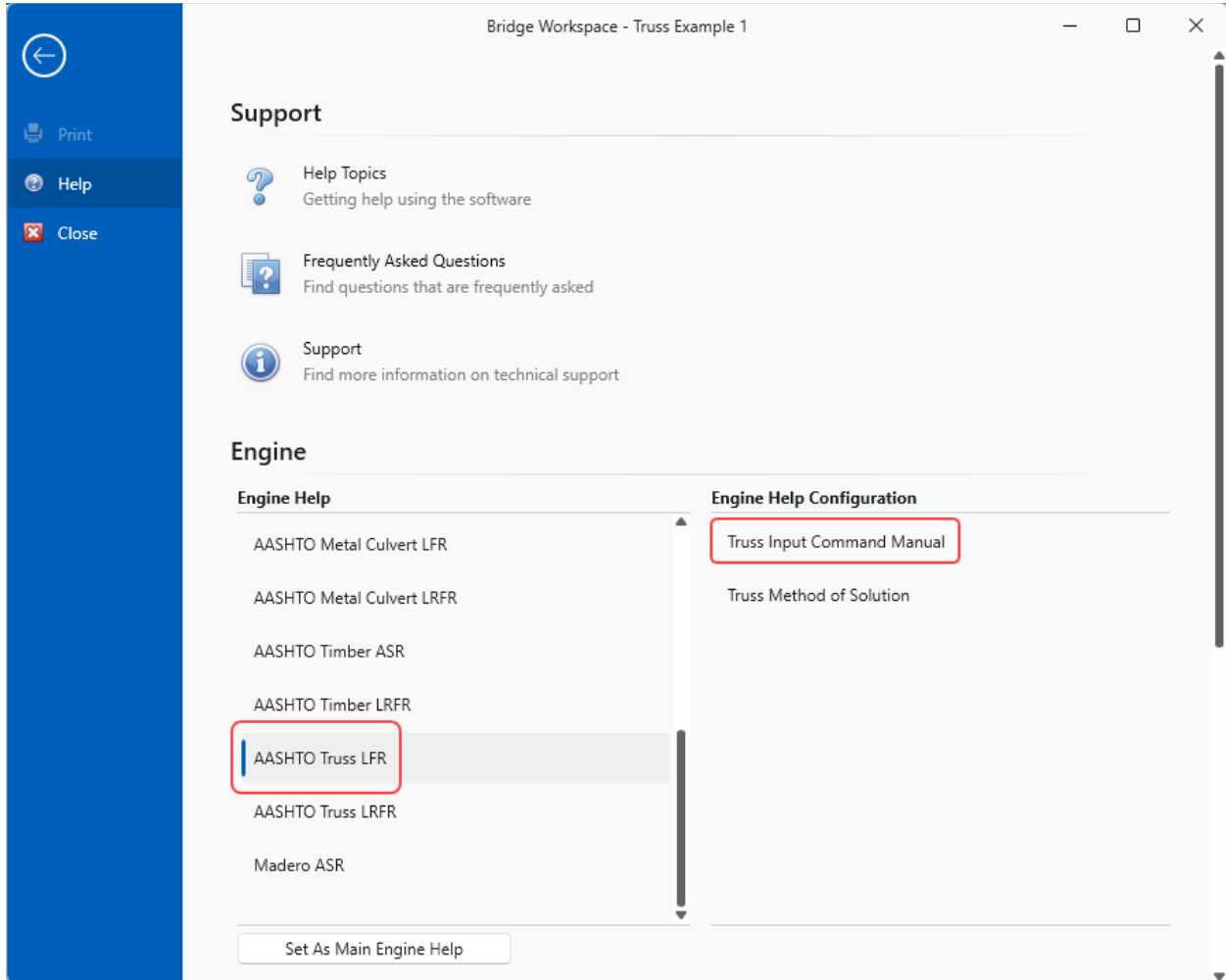

BrDR analyzes and rates trusses using the BrDR Truss analysis engine. The BrDR Truss analysis engine analyzes a finite element model of the truss and computes rating factors using the analysis method type selected (LFR or LRFR). The truss is analyzed for axial force only, bending due to load eccentricity is not considered.



The text description of the truss will include the following steel material and shape names that are entered here in the BrDR Bridge Workspace. The names in the Bridge Workspace should exactly match the names used in the truss command text description.

T1 – Truss Floorbeam Stringer Example

The partially expanded **Bridge Workspace** tree is shown below.

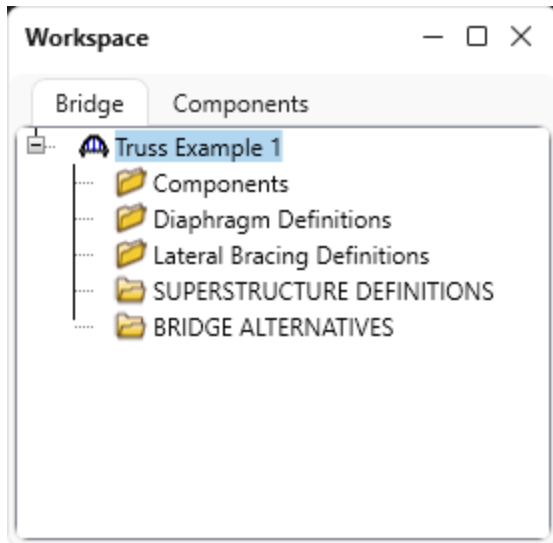

Bridge Materials

To enter the materials to be used by members of the bridge, in the **Components** tab of the **Bridge Workspace**, click on the **+** button to expand the tree for **Materials**.

The tree with the expanded **Materials** branch is shown below.

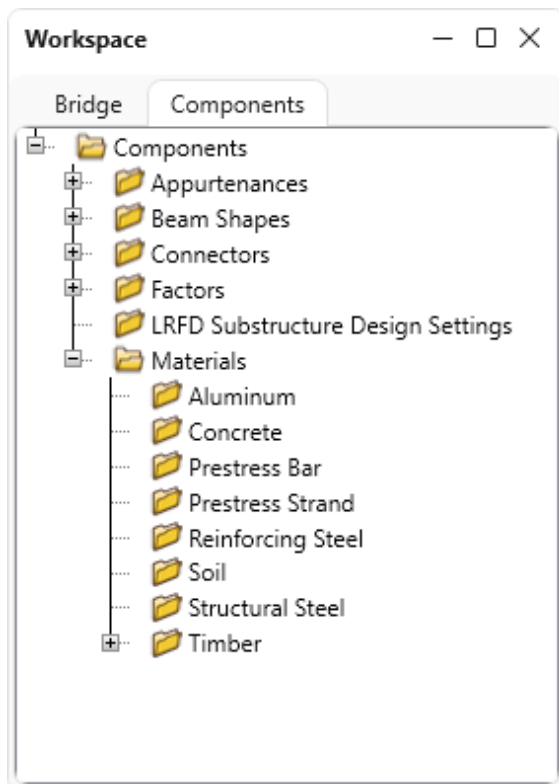

T1 – Truss Floorbeam Stringer Example

To add a new structural steel material, in the **Components** tab of the **Bridge Workspace**, expand **Materials**, click on **Structural Steel**, and select **New** from the **Manage** group of the **WORKSPACE** ribbon (or right mouse click on **Structural Steel** and select **New**). The window shown below will open.

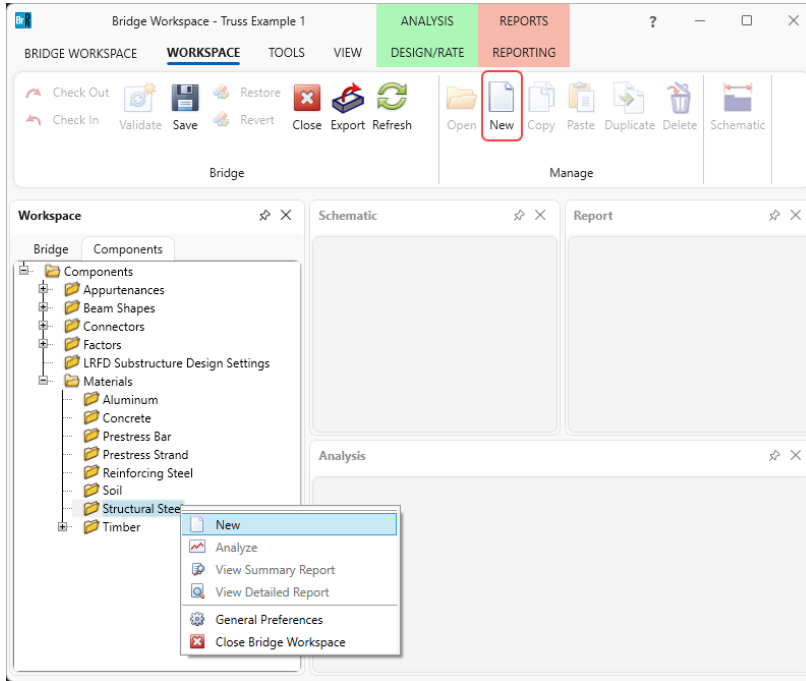

Enter the structural steel material as shown below.

The screenshot shows the "Bridge Materials - Structural Steel" dialog box. It has a title bar with a bridge icon and standard window controls. The "Name" field contains "Truss Steel" and the "Description" field contains "Built 1905 to 1936 - steel unknown". Under "Material properties", there are five rows of input fields with units: "Specified minimum yield strength (Fy): 30.0000044 ksi", "Specified minimum tensile strength (Fu): 60.0000087 ksi", "Coefficient of thermal expansion: 0.0000065 1/F", "Density: 0.49 kcf", and "Modulus of elasticity (E): 29000.004206 ksi". At the bottom, there are five buttons: "Copy to library...", "Copy from library...", "OK", "Apply", and "Cancel".

Click **OK** to apply the data and close the window.

T1 – Truss Floorbeam Stringer Example

Add another structural steel material by opening the **Bridge Materials - Structural Steel** window as described above. To save some time, add the steel material by selecting from the **Steel Materials Library** by clicking the **Copy from library** button. The following window opens.

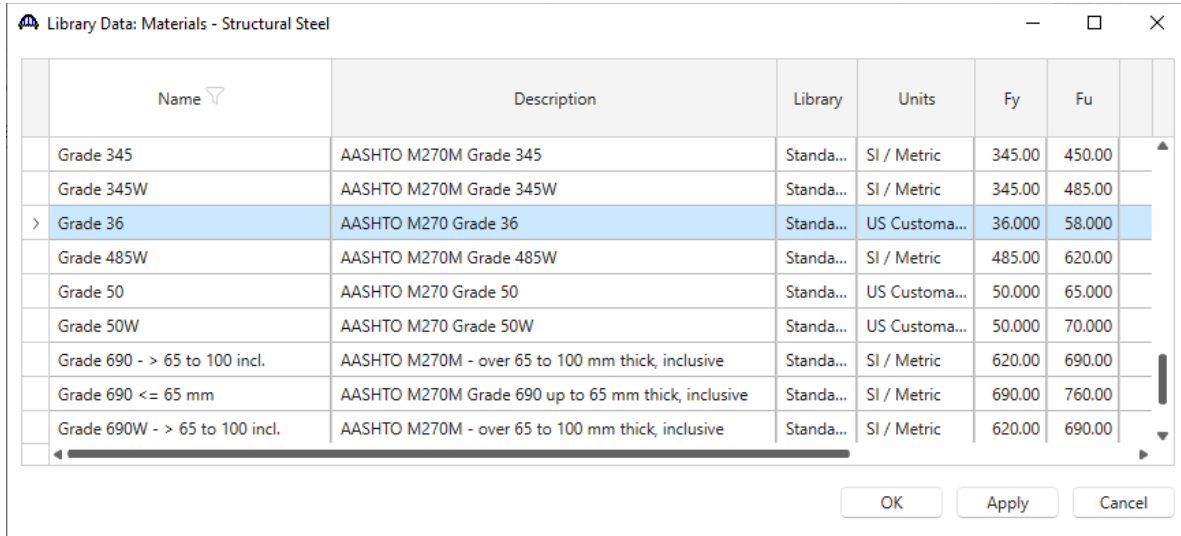

Name	Description	Library	Units	Fy	Fu
Grade 345	AASHTO M270M Grade 345	Standa...	SI / Metric	345.00	450.00
Grade 345W	AASHTO M270M Grade 345W	Standa...	SI / Metric	345.00	485.00
> Grade 36	AASHTO M270 Grade 36	Standa...	US Customa...	36.000	58.000
Grade 485W	AASHTO M270M Grade 485W	Standa...	SI / Metric	485.00	620.00
Grade 50	AASHTO M270 Grade 50	Standa...	US Customa...	50.000	65.000
Grade 50W	AASHTO M270 Grade 50W	Standa...	US Customa...	50.000	70.000
Grade 690 - > 65 to 100 incl.	AASHTO M270M - over 65 to 100 mm thick, inclusive	Standa...	SI / Metric	620.00	690.00
Grade 690 <= 65 mm	AASHTO M270M Grade 690 up to 65 mm thick, inclusive	Standa...	SI / Metric	690.00	760.00
Grade 690W - > 65 to 100 incl.	AASHTO M270M - over 65 to 100 mm thick, inclusive	Standa...	SI / Metric	620.00	690.00

Select the **Grade 36** material and click **OK**.

The selected material properties are copied to the **Bridge Materials - Structural Steel** window as shown below.

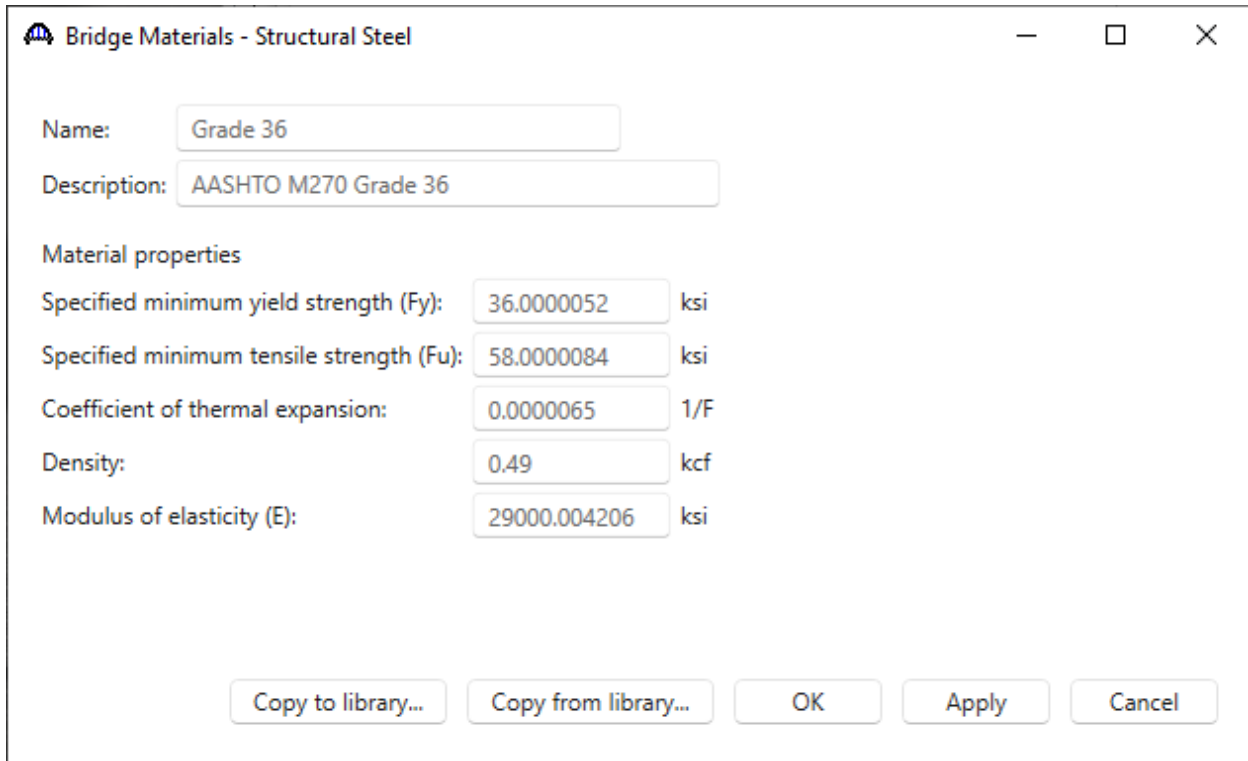

Bridge Materials - Structural Steel

Name:

Description:

Material properties

Specified minimum yield strength (Fy): ksi

Specified minimum tensile strength (Fu): ksi

Coefficient of thermal expansion: 1/F

Density: kcf

Modulus of elasticity (E): ksi

Click **OK** to apply the data and close the window.

T1 – Truss Floorbeam Stringer Example

Similarly, add a new concrete material, by clicking on **Materials, Concrete**, and select **New** from the **Manage** group of the **WORKSPACE** ribbon (or right mouse click on **Concrete** and select **New**). The window shown below will open.

Add the concrete material by selecting from the **Concrete Materials Library** by clicking the **Copy from Library** button. The following window opens:

Name	Description	Library	Units	f'c	f'ci	alpha	DL density	Modulus density	Std modulus of elasticity	LRFD modulus of elasticity	Poisson's ratio	Std Modulus of rupture	LRFD Modulus of rupture
Class A	Class A cement concrete	Standa...	SI / Metric	28...		0.00001080...	2400...	2320.00	25426.08	27730.36	0.200		3.33
> Class A (US)	Class A cement concrete	Standa...	US Customa...	4.0...		0.00000600...	0.150	0.145	3644.15	3986.55	0.200		0.48
Class B	Class B cement concrete	Standa...	SI / Metric	17...		0.00001080...	2400...	2320.00	19811.84	23520.23	0.200		2.60
Class B (US)	Class B cement concrete	Standa...	US Customa...	2.4...		0.00000600...	0.150	0.145	2822.75	3368.12	0.200		0.37
Class C	Class C cement concrete	Standa...	SI / Metric	28...		0.00001080...	2400...	2320.00	25426.08	27730.36	0.200		3.33
Class C (US)	Class C cement concrete	Standa...	US Customa...	4.0...		0.00000600...	0.150	0.145	3644.15	3986.55	0.200		0.48

T1 – Truss Floorbeam Stringer Example

Select the **Class A (US)** material and click **OK**. The selected material properties are copied to the **Bridge Materials – Concrete** window as shown below.

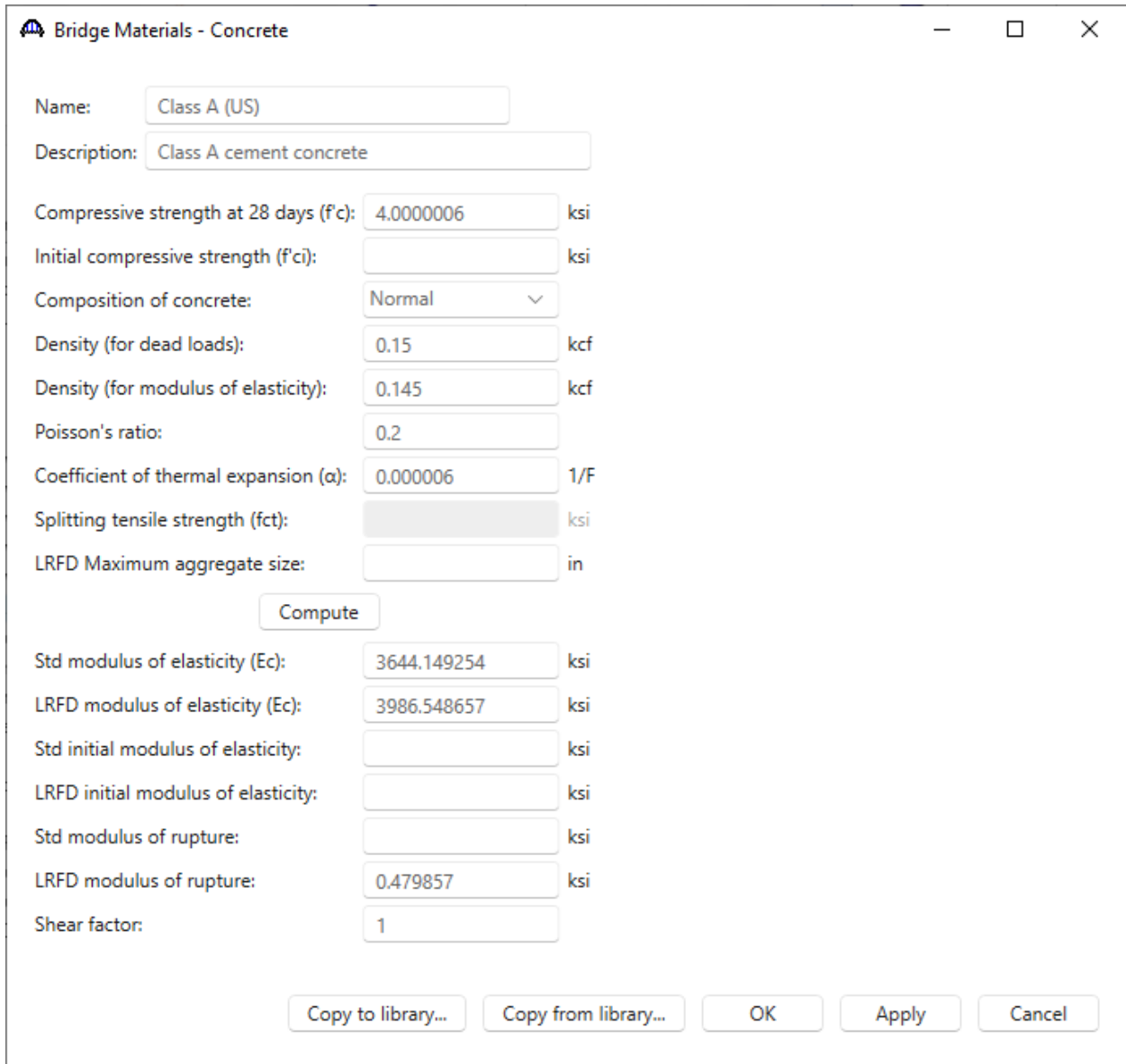

The screenshot shows a software dialog box titled "Bridge Materials - Concrete". It contains various input fields for material properties. The "Name" field is set to "Class A (US)" and the "Description" field is set to "Class A cement concrete". The "Compressive strength at 28 days (f'c)" is 4.0000006 ksi. Other fields include "Initial compressive strength (f'ci)", "Composition of concrete" (Normal), "Density (for dead loads)" (0.15 kcf), "Density (for modulus of elasticity)" (0.145 kcf), "Poisson's ratio" (0.2), "Coefficient of thermal expansion (α)" (0.000006 1/F), "Splitting tensile strength (fct)", "LRFD Maximum aggregate size", "Std modulus of elasticity (Ec)" (3644.149254 ksi), "LRFD modulus of elasticity (Ec)" (3986.548657 ksi), "Std initial modulus of elasticity", "LRFD initial modulus of elasticity", "Std modulus of rupture", "LRFD modulus of rupture" (0.479857 ksi), and "Shear factor" (1). A "Compute" button is located below the aggregate size field. At the bottom, there are buttons for "Copy to library...", "Copy from library...", "OK", "Apply", and "Cancel".

Property	Value	Unit
Name	Class A (US)	
Description	Class A cement concrete	
Compressive strength at 28 days (f'c)	4.0000006	ksi
Initial compressive strength (f'ci)		ksi
Composition of concrete	Normal	
Density (for dead loads)	0.15	kcf
Density (for modulus of elasticity)	0.145	kcf
Poisson's ratio	0.2	
Coefficient of thermal expansion (α)	0.000006	1/F
Splitting tensile strength (fct)		ksi
LRFD Maximum aggregate size		in
Std modulus of elasticity (Ec)	3644.149254	ksi
LRFD modulus of elasticity (Ec)	3986.548657	ksi
Std initial modulus of elasticity		ksi
LRFD initial modulus of elasticity		ksi
Std modulus of rupture		ksi
LRFD modulus of rupture	0.479857	ksi
Shear factor	1	

Click **OK** to apply the data and close the window.

T1 – Truss Floorbeam Stringer Example

Beam Shapes

To enter a steel beam shape to be used in this bridge expand the tree labeled **Beam Shapes** and **Steel Shapes** as shown below. The partially expanded **Components** tree with the **Steel Shapes** node expanded is shown below.

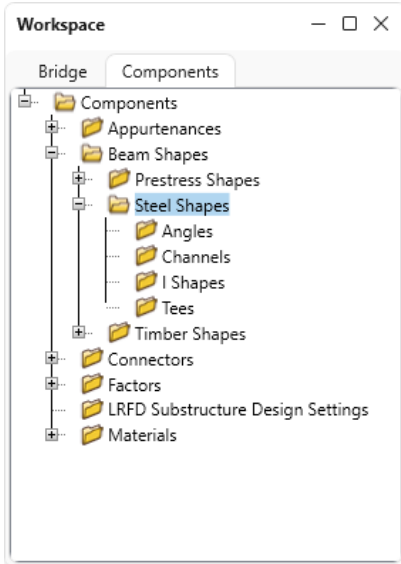

To add a new steel I shape, click on the **I Shapes** node in the **Components** tree and select **New** from the **Manage** group of the **WORKSPACE** ribbon (or right mouse click on **I Shapes** and select **New** or double click on **I Shapes** in the **Components** tree). The window shown below will open.

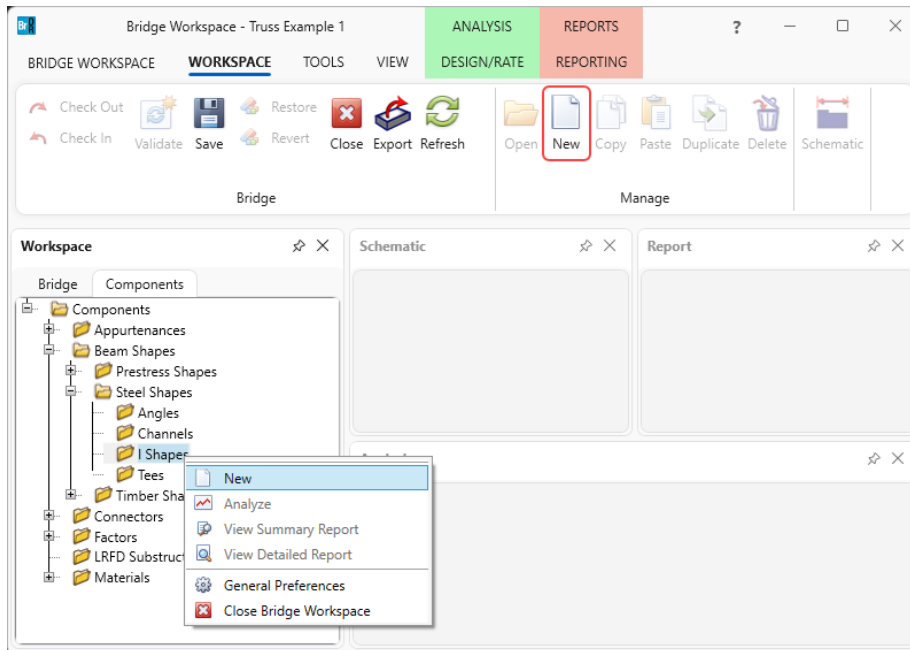

T1 – Truss Floorbeam Stringer Example

Select the **Rolled shape type** as **W shape** and click the **Copy from library...** button. The **Steel Shape Selection** window will appear.

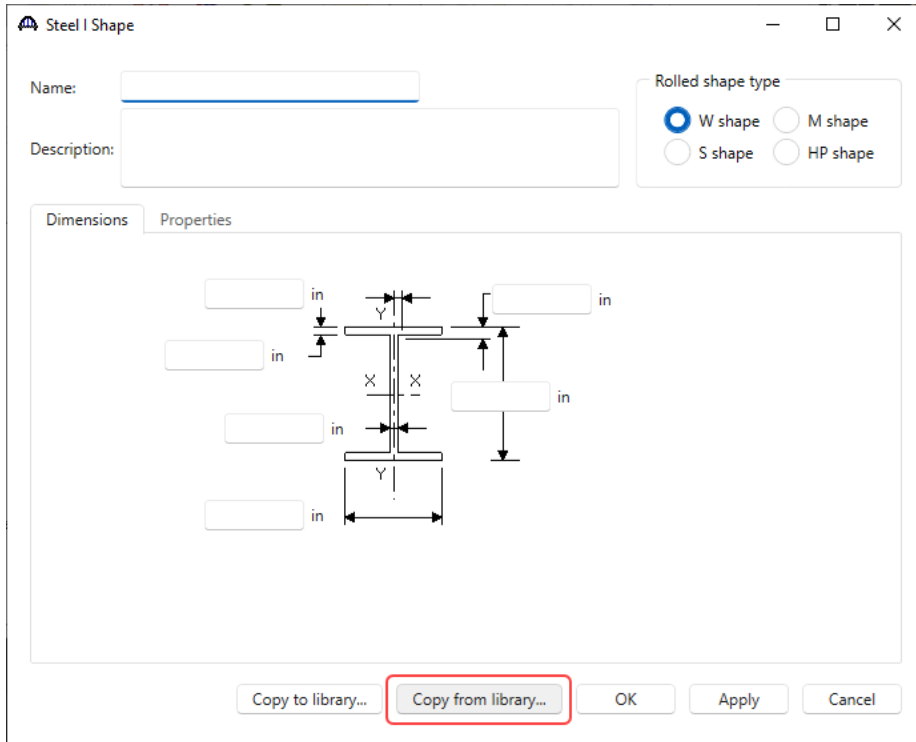

This window displays all the steel shapes available in the library. The list can be sorted by clicking on any of the column headers (e.g., **Shape**, **Year**, **Depth** etc.). Select **W12x79 (Year – 1994)** and click **OK**.

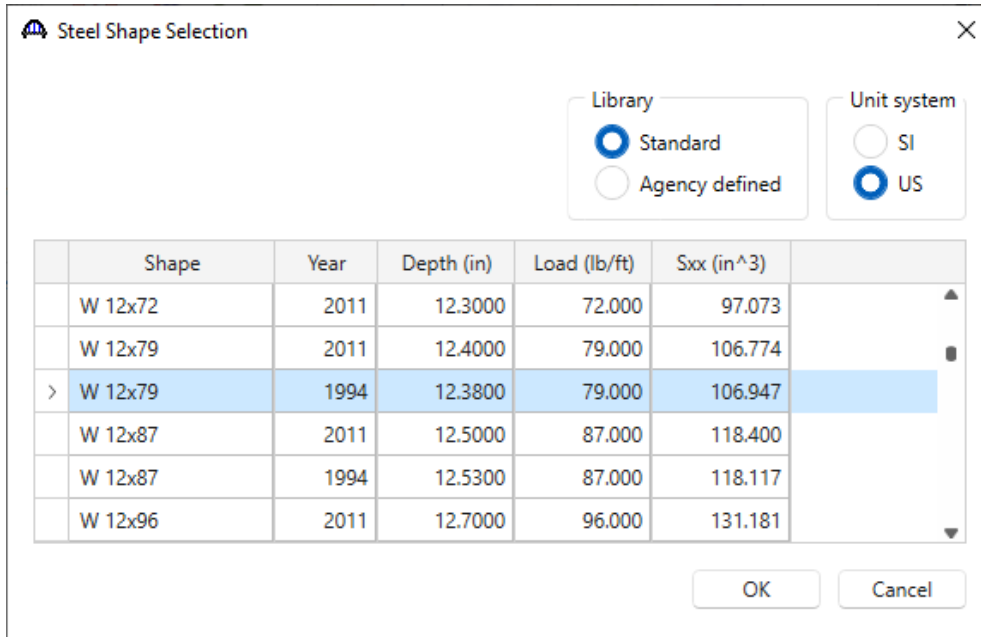

T1 – Truss Floorbeam Stringer Example

The beam properties are copied to the **Steel I Shape** window as shown below.

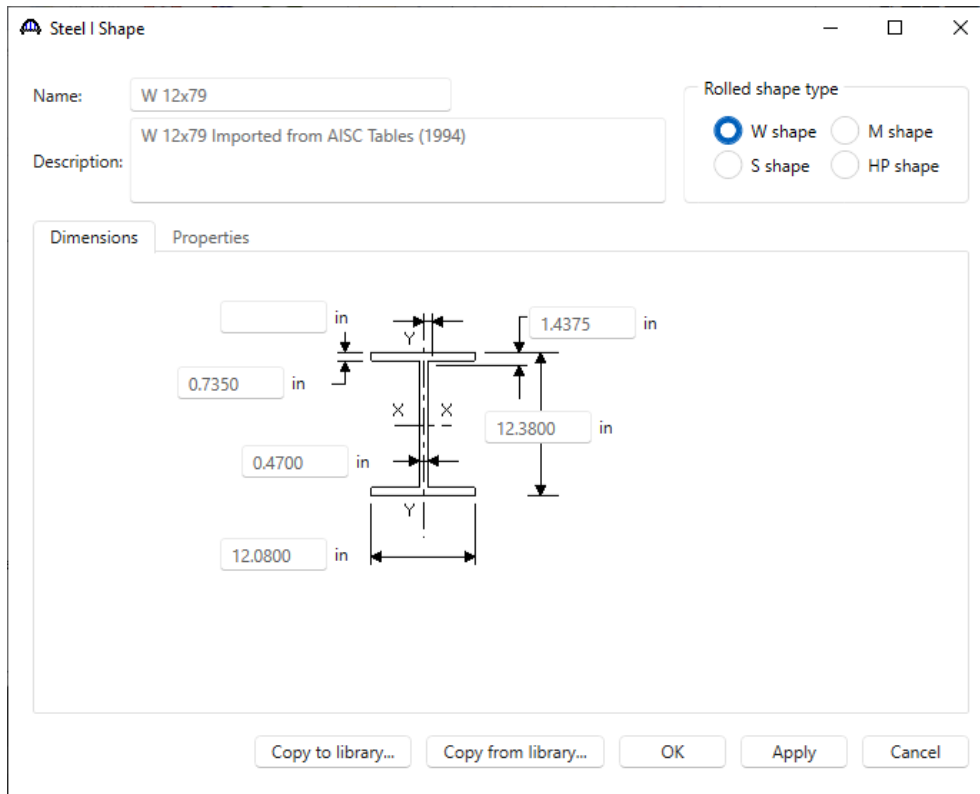

Click **OK** to apply the data and close the window.

Similarly, add the following steel I shapes:

W12x65 (Year – 1994)

W21x57 (Year – 1994)

W16x57 (Year – 1994)

W33x221 (Year – 1994)

T1 – Truss Floorbeam Stringer Example

To add a new steel channel shape, click on the **Channels** node in the **Components** tree and select **New** from the **Manage** group of the **WORKSPACE** ribbon (or right mouse click on **Channels** and select **New** or double click on **Channels** in the **Components** tree). Enter the following information in **Dimensions** and **Properties** tabs as shown below, since it is not available in the standard library.

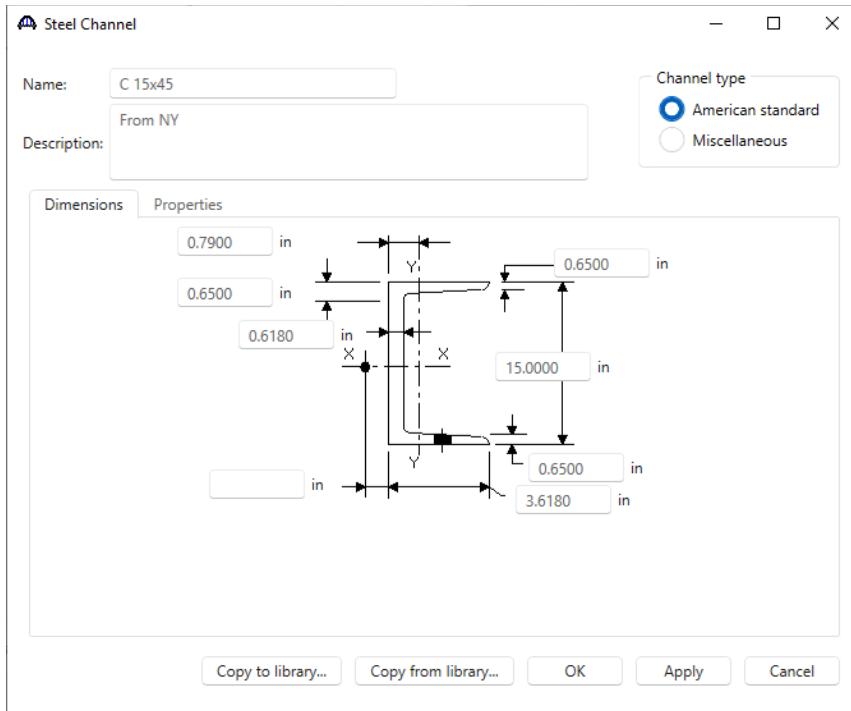

The image shows the 'Steel Channel' dialog box with the 'Dimensions' tab selected. The 'Name' field contains 'C 15x45' and the 'Description' field contains 'From NY'. The 'Channel type' section has 'American standard' selected. The main area displays a technical drawing of a channel with various dimensions: 0.7900 in, 0.6500 in, 0.6180 in, 0.6500 in, 15.0000 in, 0.6500 in, 3.6180 in, and an empty input field. The drawing also shows the X and Y axes.

Steel Channel

Name: C 15x45

Description: From NY

Channel type

American standard

Miscellaneous

Dimensions

0.7900 in

0.6500 in

0.6180 in

0.6500 in

15.0000 in

0.6500 in

3.6180 in

Copy to library... Copy from library... OK Apply Cancel

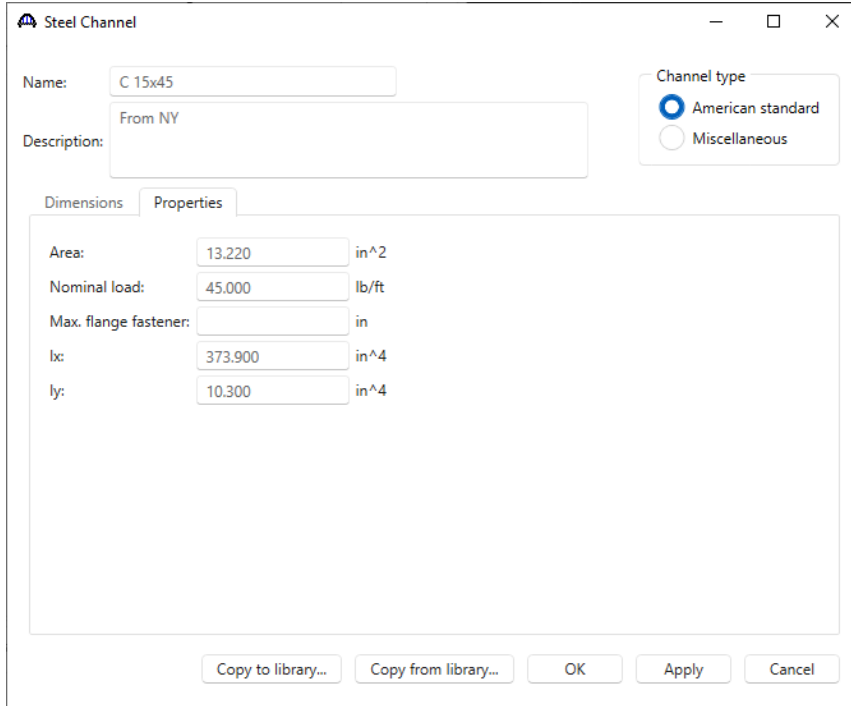

The image shows the 'Steel Channel' dialog box with the 'Properties' tab selected. The 'Name' field contains 'C 15x45' and the 'Description' field contains 'From NY'. The 'Channel type' section has 'American standard' selected. The main area displays the following properties: Area: 13.220 in^2, Nominal load: 45.000 lb/ft, Max. flange fastener: in, Ix: 373.900 in^4, and Iy: 10.300 in^4.

Steel Channel

Name: C 15x45

Description: From NY

Channel type

American standard

Miscellaneous

Dimensions

Properties

Area: 13.220 in²

Nominal load: 45.000 lb/ft

Max. flange fastener: in

I_x: 373.900 in⁴

I_y: 10.300 in⁴

Copy to library... Copy from library... OK Apply Cancel

Click **OK** to apply the data and close the window.

T1 – Truss Floorbeam Stringer Example

Similarly add the following channel shapes as shown below.

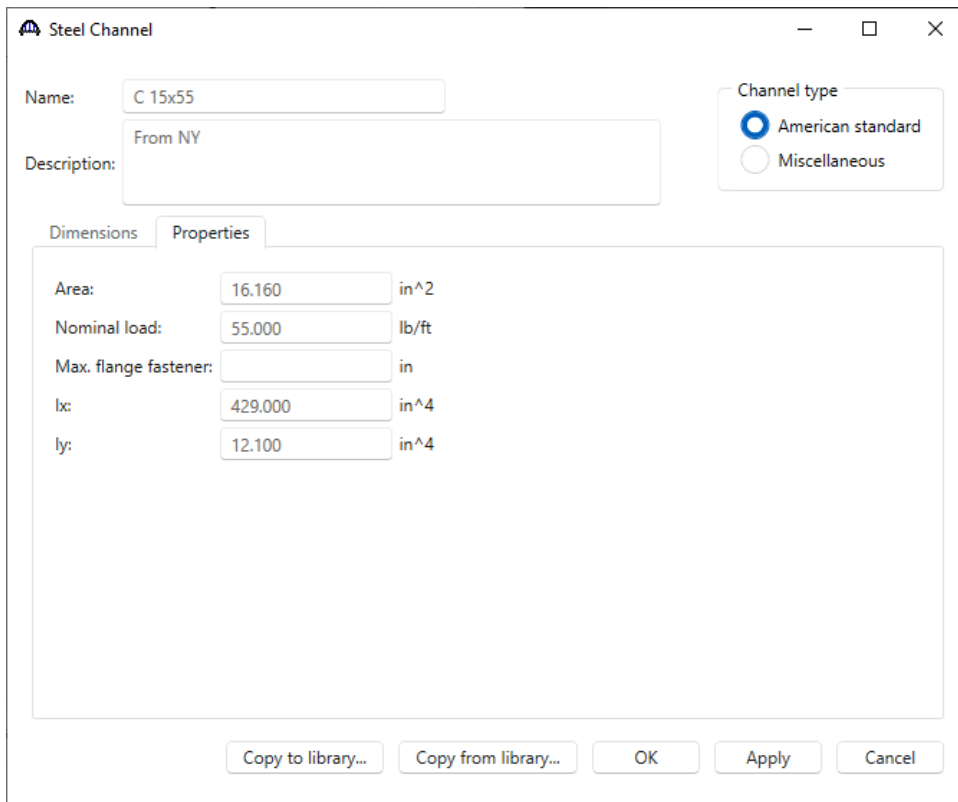
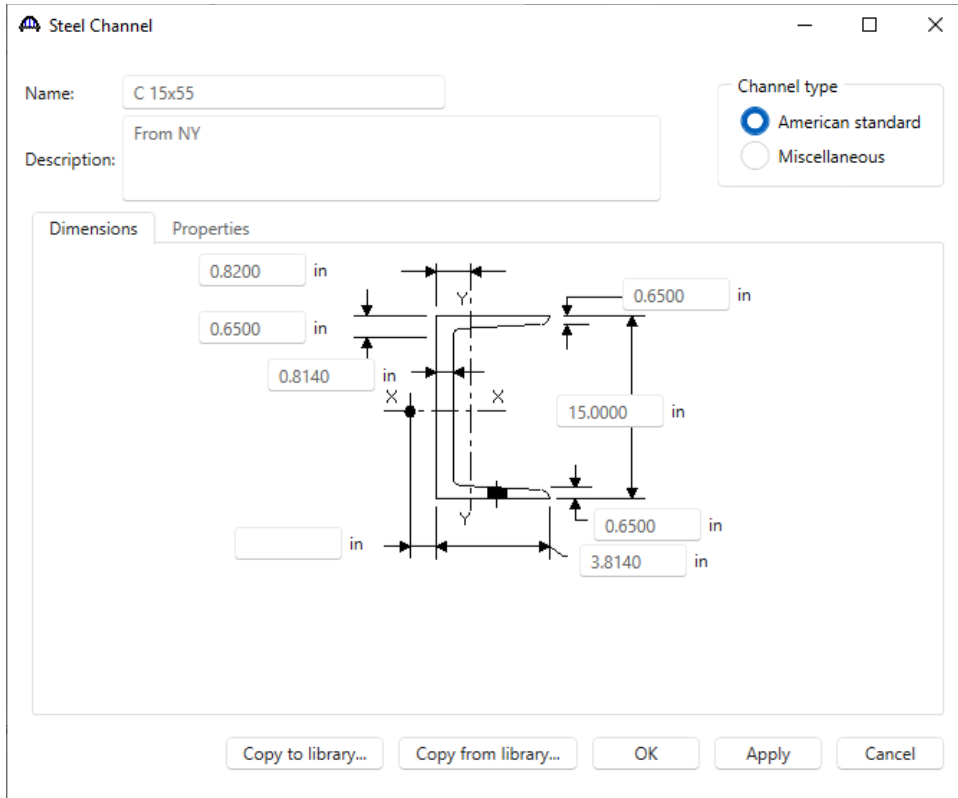

T1 – Truss Floorbeam Stringer Example

Steel Channel

Name:

Description:

Channel type:
 American standard
 Miscellaneous

Dimensions | **Properties**

0.7980 in
1.4375 in
0.7160 in
0.5830 in
0.6500 in
15.0000 in
3.7160 in

Copy to library... Copy from library... OK Apply Cancel

Steel Channel

Name:

Description:

Channel type:
 American standard
 Miscellaneous

Dimensions | **Properties**

Area: in²

Nominal load: lb/ft

Max. flange fastener: in

I_x: in⁴

I_y: in⁴

Copy to library... Copy from library... OK Apply Cancel

T1 – Truss Floorbeam Stringer Example

Bridge Appurtenances

To enter the appurtenances to be used within the bridge, expand the tree branch labeled **Appurtenances**. To define a generic barrier, select **Generic** and click on **New** from the **Manage** button on the **WORKSPACE** ribbon (or double click on **Generic** in the **Components** tree).

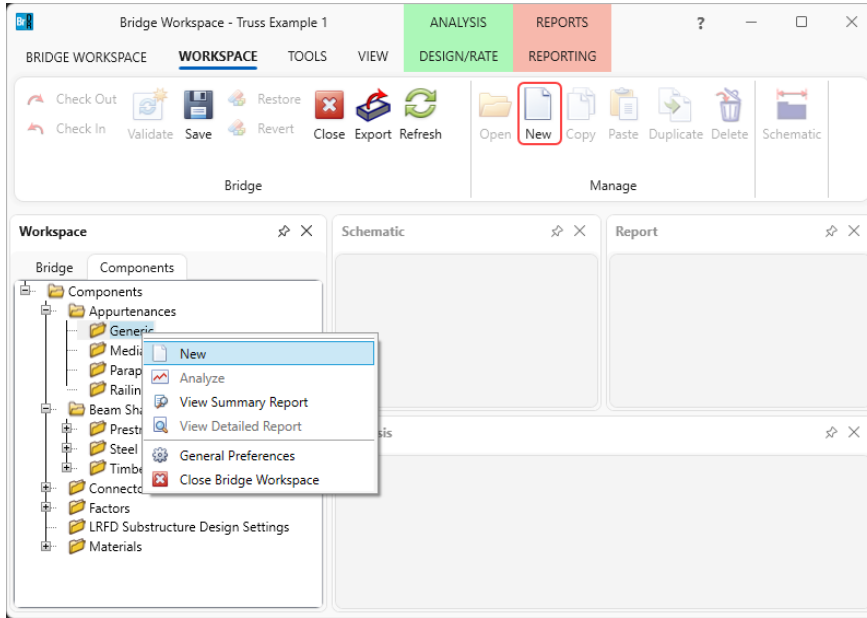

Enter the following generic appurtenance to model the curb.

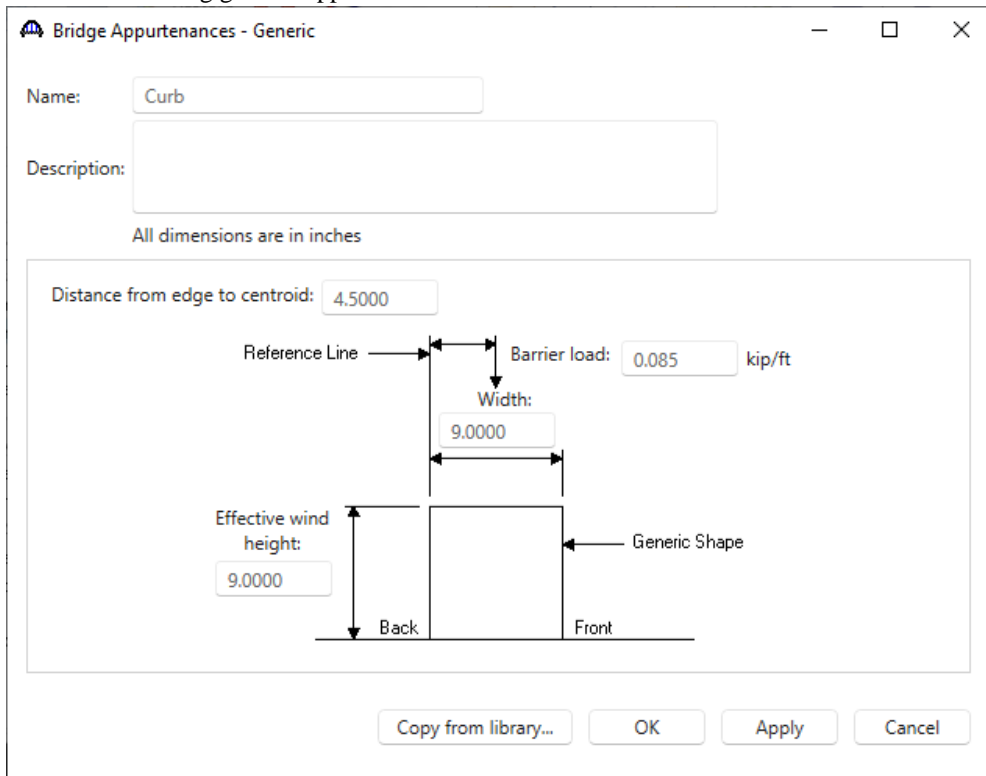

Click **OK** to apply the data and close the window.

T1 – Truss Floorbeam Stringer Example

The partially expanded **Bridge Workspace** tree is shown below.

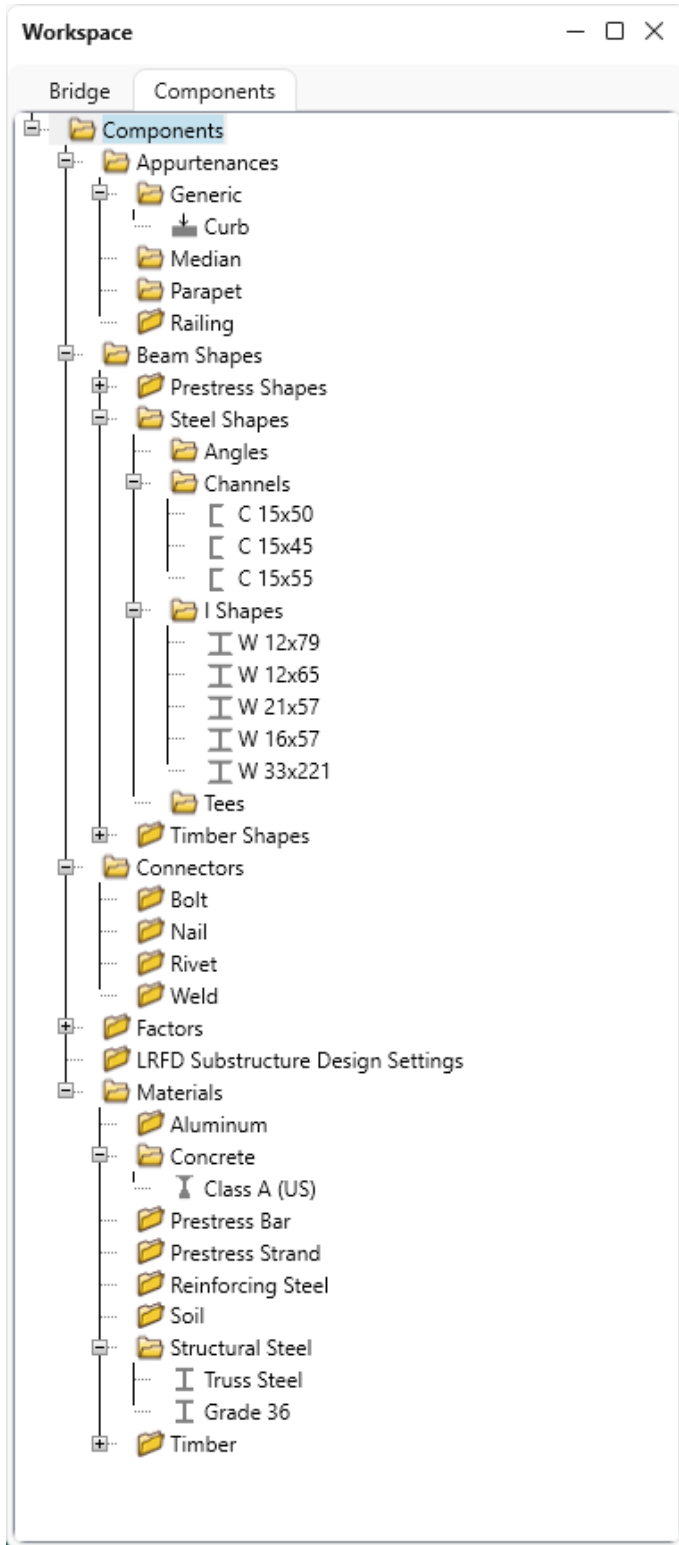

T1 – Truss Floorbeam Stringer Example

Truss-floorbeam-stringer system superstructure.

Return to the **Bridge** tab of the **Bridge Workspace**, double click on **SUPERSTRUCTURE DEFINITIONS** (or click on **SUPERSTRUCTURE DEFINITIONS** and select **New** from the **Manage** group of the **WORKSPACE** ribbon or right mouse click on **SUPERSTRUCTURE DEFINITIONS** and select **New** from the popup menu) to create a new structure definition.

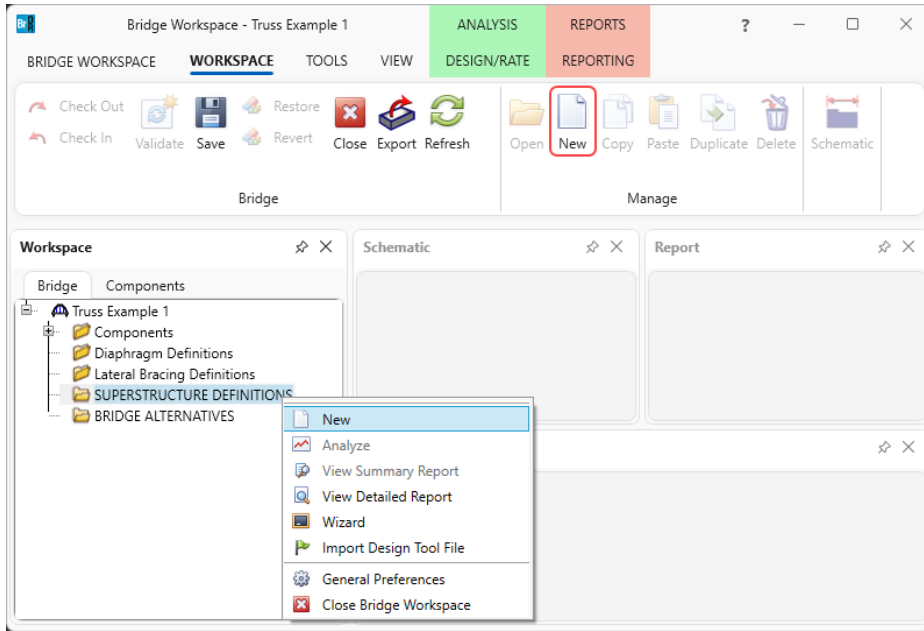

Selecting **Truss system superstructure** displays two types of truss system superstructure definitions. Select **Truss Floorbeam Stringer** and click **OK**.

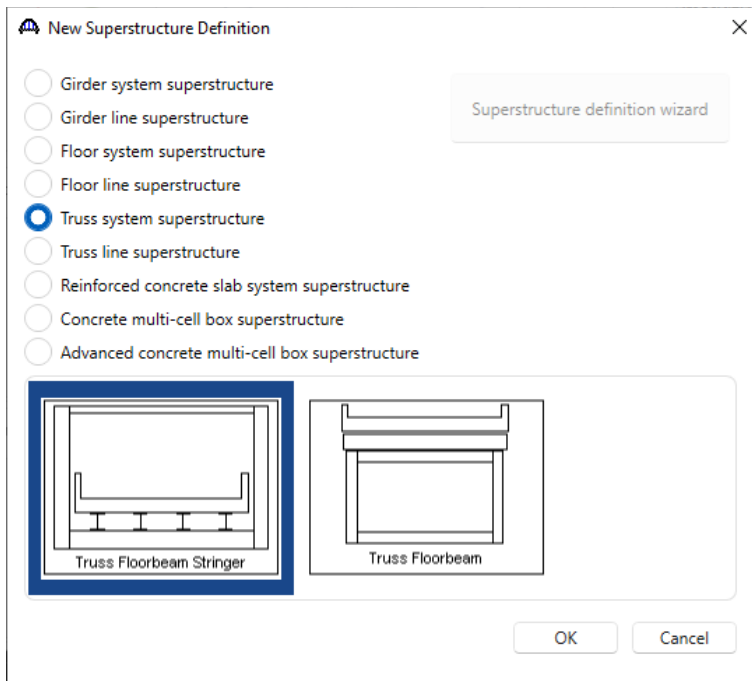

T1 – Truss Floorbeam Stringer Example

The **Truss Floorbeam Stringer Floor System Superstructure Definition** window will open. Enter the data as shown below.

 Be sure to select the Main member configuration as **Through**. This specifies that live load is applied to the bottom chord of the truss.

Click **OK** to apply the data and close the window.

Stringer Units are the portions of the structure where the stringers are to be analyzed as structurally continuous units. In this structure, the stringers are simple spans and there are 6 stringer units.

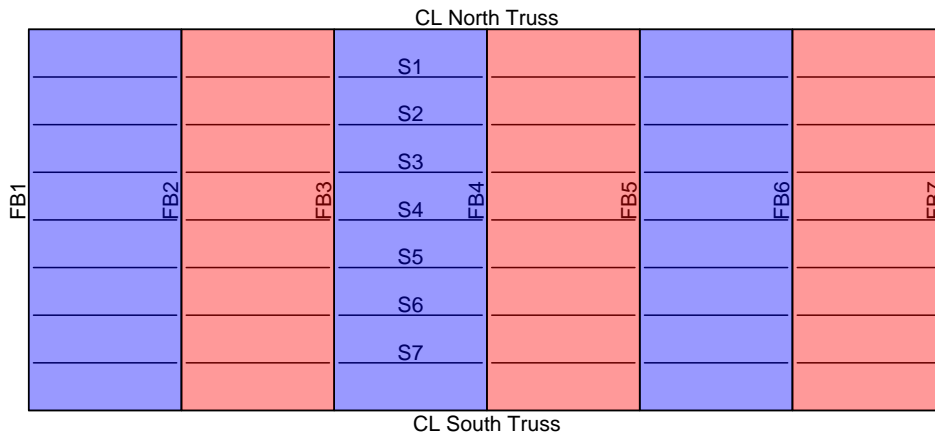

T1 – Truss Floorbeam Stringer Example

Load Case Description

Expand the **Truss [TFS]** superstructure definition and double-click on the **Load Case Description** node in the **Bridge Workspace** tree to open the **Load Case Description** window. Click on the **Add default load case description** button to create the following load cases.

Load case name	Description	Stage	Type	Time* (days)
DC1	DC acting on non-composite section	Non-composite (Stage 1)	D,DC	
DC2	DC acting on long-term composite section	Composite (long term) (Stag...	D,DC	
DW	DW acting on long-term composite secti...	Composite (long term) (Stag...	D,DW	
> SIP Forms	Weight due to stay-in-place forms	Non-composite (Stage 1)	D,DC	

*Prestressed members only

Click **OK** to apply the data and close the window.

Structure Framing Plan Detail – Layout

Double-click on **Framing Plan Detail** in the **Bridge Workspace** tree to describe the framing plan in the **Structure Plan Details** window. Enter the truss spacing and stringer spacing as shown below.

Number of main member spans: 1 Number of main members: 2 Number of stringers: 7

Layout Diaphragms

Main member support skew:

Support	Skew (degrees)
> 1	0.000
2	0.000

Member spacing orientation:

Perpendicular to member
 Along support

Main member spacing:

Truss bay	Member spacing (ft)	
	Start of member	End of member
> 1	35.00	35.00

Stringer spacing:

Stringer bay	Stringer spacing (ft)	
	Start of stringer	End of stringer
1	5.00	5.00
2	5.00	5.00
3	5.00	5.00
4	5.00	5.00
5	5.00	5.00
> 6	5.00	5.00

This structure does not have a diaphragm or lateral bracing on the truss members, so no data is entered on the **Diaphragms** tab. Click **OK** to apply the data and close the window.

T1 – Truss Floorbeam Stringer Example

Schematic - Framing Plan Detail

While the **Framing Plan Detail** is selected in the **Bridge Workspace** tree, open the schematic for the framing plan by selecting the **Schematic** button on the **WORKSPACE** ribbon (or right click on **Framing Plan Detail** and select **Schematic** from the menu).

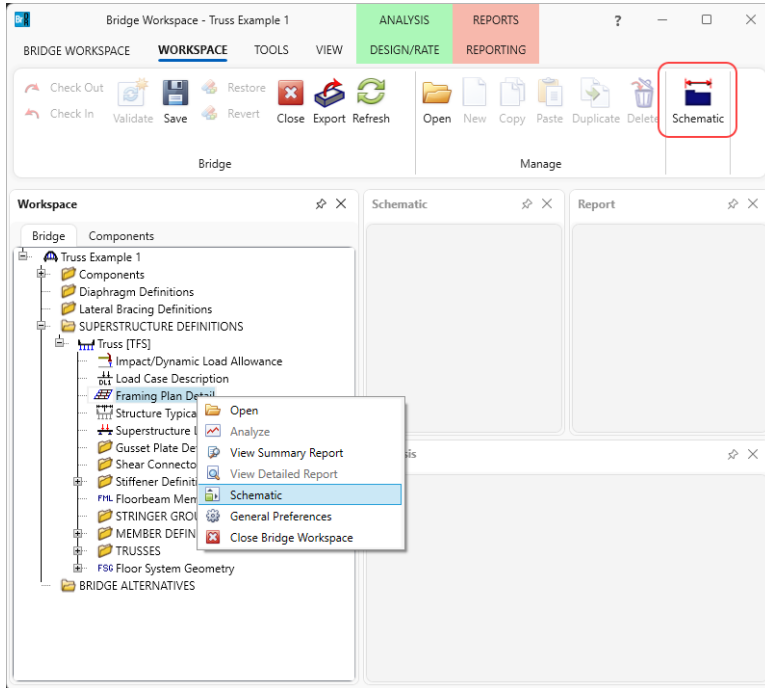

The schematic for the framing plan does not show any floorbeams and stringers because the floorbeams and stringers are not yet defined.



T1 – Truss Floorbeam Stringer Example

Structure Typical Section - Deck

Next define the structure typical section by double-clicking on **Structure Typical Section** node in the **Bridge Workspace** tree. Input the data to locate the truss and stringers with respect to the left edge of the deck as shown below.

Structure Typical Section

Distance from left edge of deck to superstructure definition ref. line

Distance from right edge of deck to superstructure definition ref. line

Superstructure Definition Reference Line

Left edge of deck to first stringer

Left edge of deck to first main member

Deck Deck (cont'd) Parapet Median Railing Generic Sidewalk Lane position Striped lanes Wearing surface

Superstructure definition reference line is within the bridge deck.

	Start	End
Distance from left edge of deck to superstructure definition reference line:	16.50 ft	16.50 ft
Distance from right edge of deck to superstructure definition reference line:	16.50 ft	16.50 ft
Left edge of deck to first main member:	-1.00 ft	-1.00 ft
Left edge of deck to first stringer:	1.50 ft	1.50 ft

Enter a negative distance to indicate that the truss is to the left of the edge of deck.

OK Apply Cancel

T1 – Truss Floorbeam Stringer Example

Enter the remaining structure typical section data as shown below.

Structure Typical Section – Deck (cont'd)

The **Deck (cont'd)** tab is used to define the **Deck concrete** and the **Total deck thickness**. The material used for the deck concrete is selected from the list of bridge materials. Enter the data as shown below.

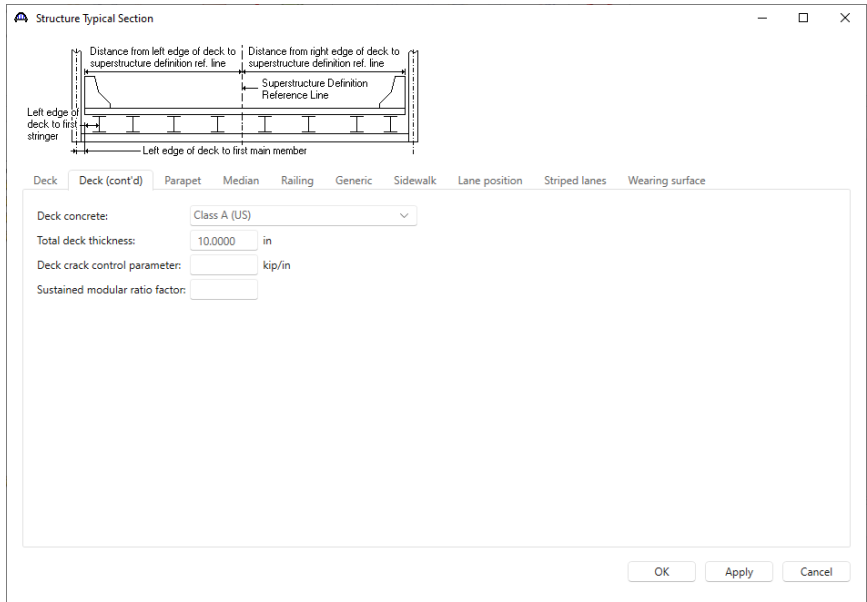

Structure Typical Section – Generic

Click the **New** button to add a row to the table. The **Name** of the generic barrier defaults to the only barrier described for the bridge. The completed tab is shown below.

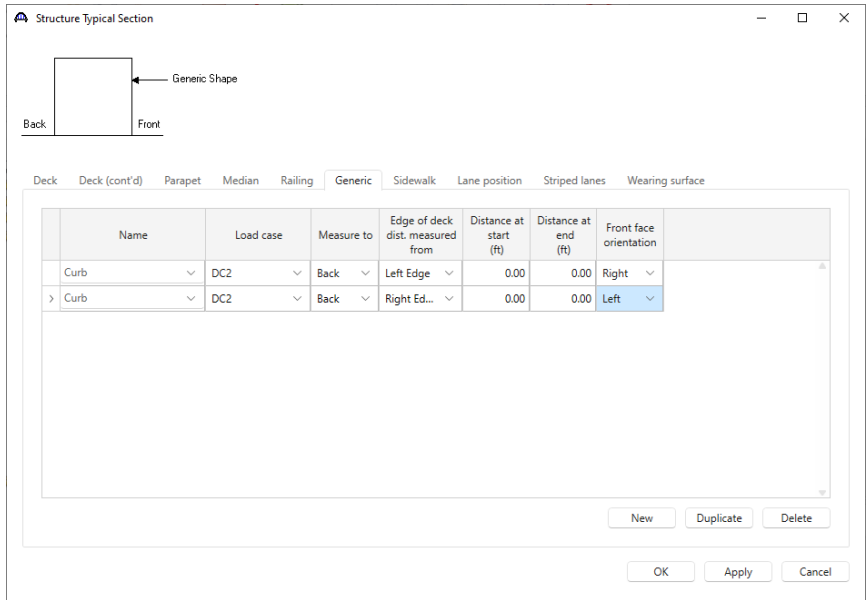

T1 – Truss Floorbeam Stringer Example

Structure Typical Section – Lane Positions

Select the **Lane position** tab. This tab defines the travelways for the vehicles. Use the **Compute...** button to compute the lane positions. A window showing the results of the computation opens. Click **Apply** to apply the computed values.

Travelway number	Distance from left edge of travelway to superstructure definition reference line at start (A) (ft)	Distance from right edge of travelway to superstructure definition reference line at start (B) (ft)	Distance from left edge of travelway to superstructure definition reference line at end (A) (ft)	Distance from right edge of travelway to superstructure definition reference line at end (B) (ft)
1	-15.75	15.75	-15.75	15.75

Buttons: Apply, Cancel

The **Lane Position** tab is populated as shown below.

Structure Typical Section

Deck Deck (cont'd) Parapet Median Railing Generic Sidewalk **Lane position** Striped lanes Wearing surface

Travelway number	Distance from left edge of travelway to superstructure definition reference line at start (A) (ft)	Distance from right edge of travelway to superstructure definition reference line at start (B) (ft)	Distance from left edge of travelway to superstructure definition reference line at end (A) (ft)	Distance from right edge of travelway to superstructure definition reference line at end (B) (ft)
1	-15.75	15.75	-15.75	15.75

LRFD fatigue
 Lanes available to trucks:
 Override Truck fraction:

Buttons: Compute, New, Duplicate, Delete, OK, Apply, Cancel

Click **OK** to apply the data and close the window.

T1 – Truss Floorbeam Stringer Example

Schematic – Structure Typical Section

While **Structure Typical Section** is selected in the **Bridge Workspace** tree, open the schematic for the structure typical section by selecting the **Schematic** button on the **WORKSPACE** ribbon (or right click on **Structure Typical Section** in the **Bridge Workspace** and select **Schematic** from the menu).

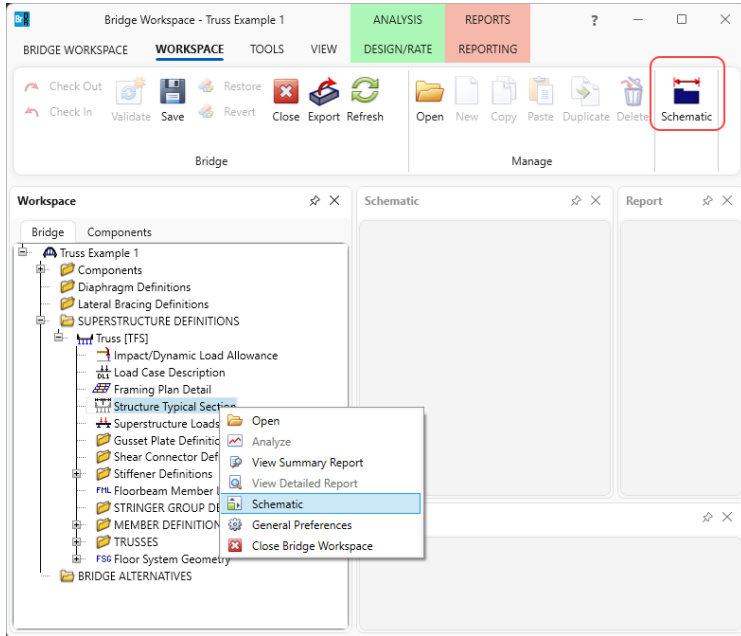

The following schematic will be displayed.

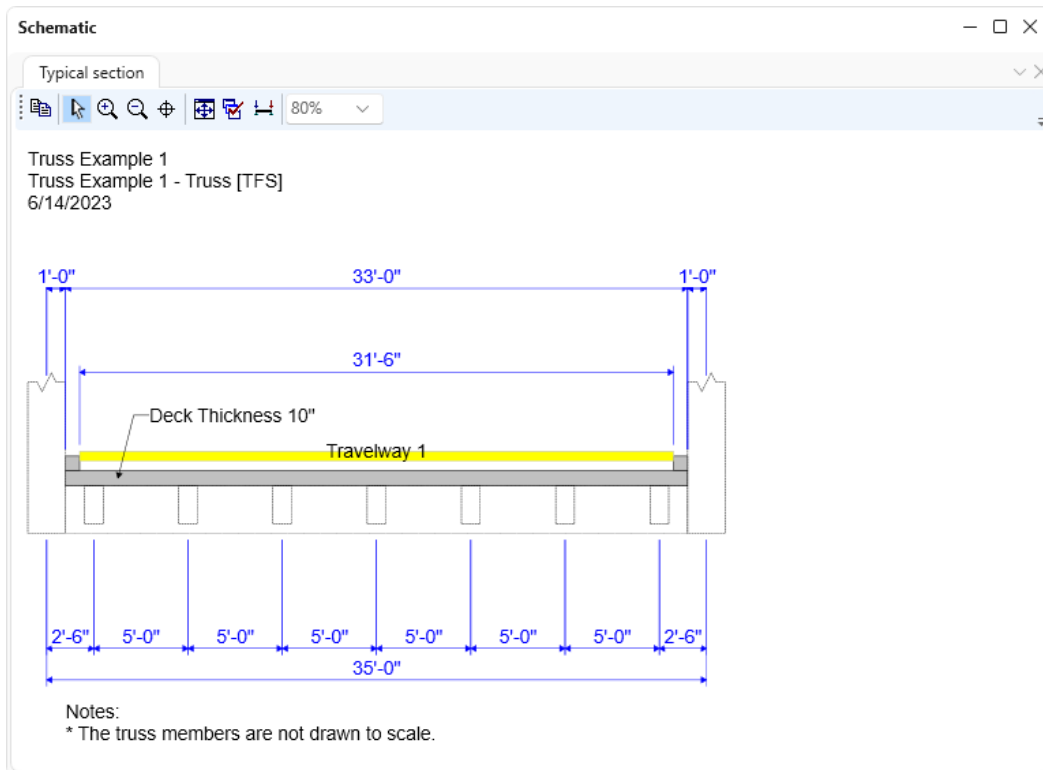

T1 – Truss Floorbeam Stringer Example

Floorbeam Member Locations

Double click on the **Floorbeam Member Locations** node in the **Bridge Workspace** tree to open the **Floorbeam Member Locations** window as shown below.

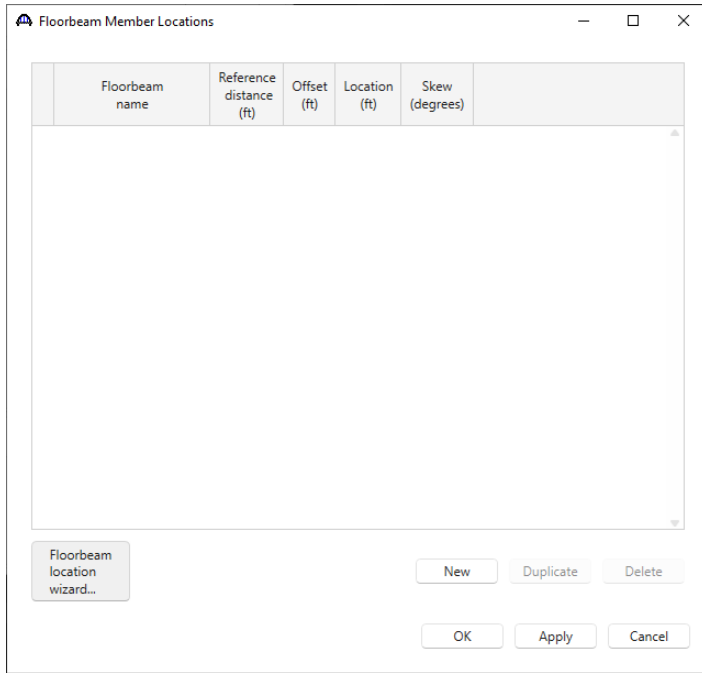

Click the **Floorbeam location wizard...** button and enter the following spacing to add floorbeams for the entire structure. Click **OK** to add the floorbeams.

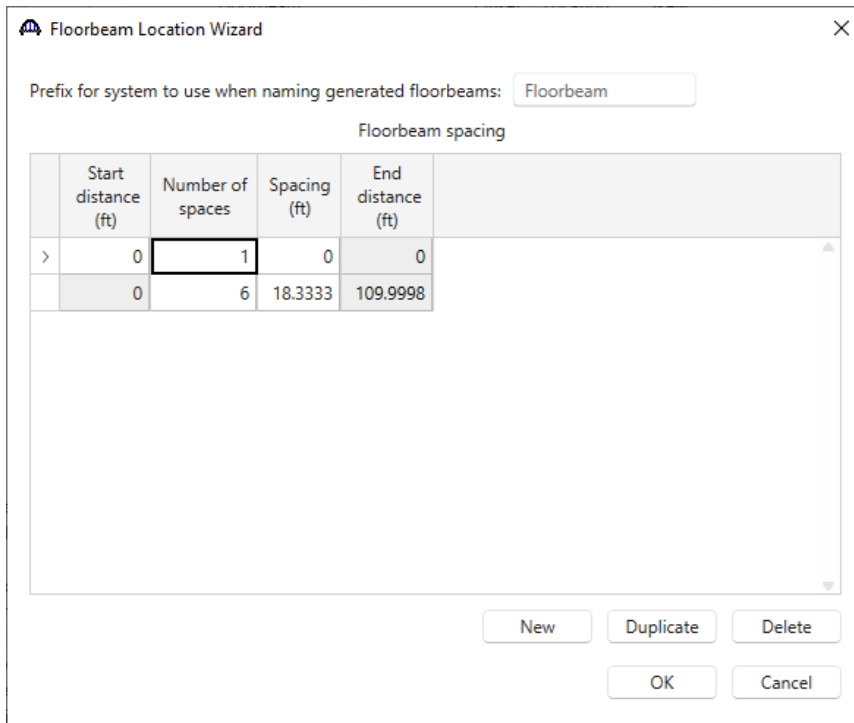

T1 – Truss Floorbeam Stringer Example

The floorbeam member locations created for the structure are shown below.

	Floorbeam name	Reference distance (ft)	Offset (ft)	Location (ft)	Skew (degrees)
	Floorbeam1	0	0	0	0
	Floorbeam2	0	18.3333	18.3333	0
	Floorbeam3	18.3333	18.3333	36.6666	0
	Floorbeam4	36.6666	18.3333	54.9999	0
	Floorbeam5	54.9999	18.3333	73.3332	0
	Floorbeam6	73.3332	18.3333	91.6665	0
>	Floorbeam7	91.6665	18.3333	109.9998	0

Floorbeam location wizard...

New Duplicate Delete

OK Apply Cancel

Click **OK** to apply the data and close the window.

T1 – Truss Floorbeam Stringer Example

Stringer Group Definition Geometry – Stringer span lengths

A stringer group definition contains data regarding a portion of the structure where the stringers are structurally continuous. The stringers in this structure all have the same span data. They are simple spans and are supported by 2 floorbeams. Create one stringer group definition containing this geometry data and then apply this stringer group definition to all the 6 stringer units in this structure. Double click on the **STRINGER GROUP DEFINITION GEOMETRY** in the **Bridge Workspace** tree to define the geometry for a stringer group definition as shown below.

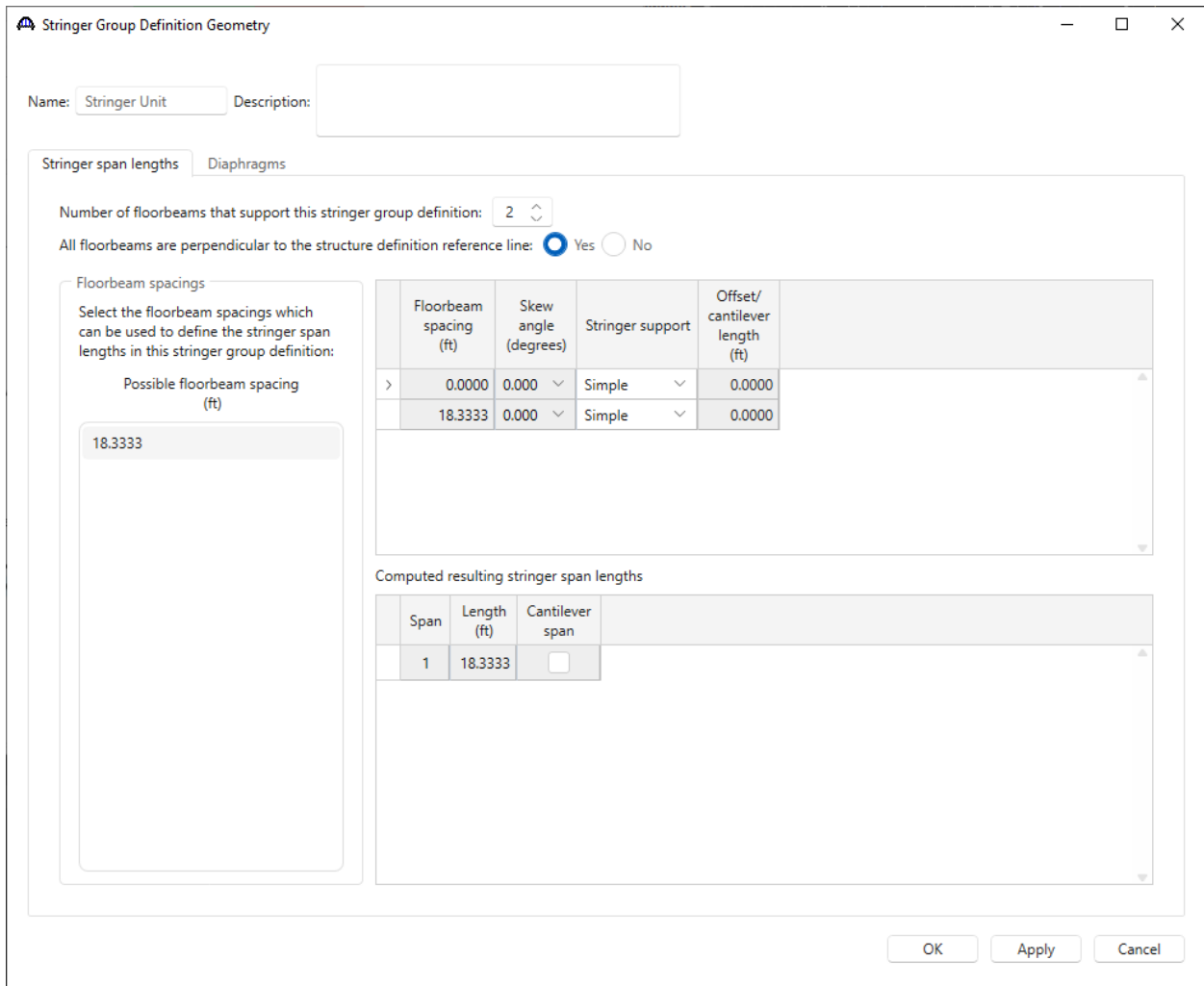

Click **OK** to apply the data and close the window.

T1 – Truss Floorbeam Stringer Example

Describing a Floorbeam Member Definition

Expand the **MEMBER DEFINITIONS** node in the **Bridge Workspace** tree and double click on the **FLOORBEAM DEFINITIONS** node (or select **FLOORBEAM DEFINITIONS** and click **New** from the **Manage** group of the **WORKSPACE** ribbon) to open the **New Floorbeam Definition** window as shown below.

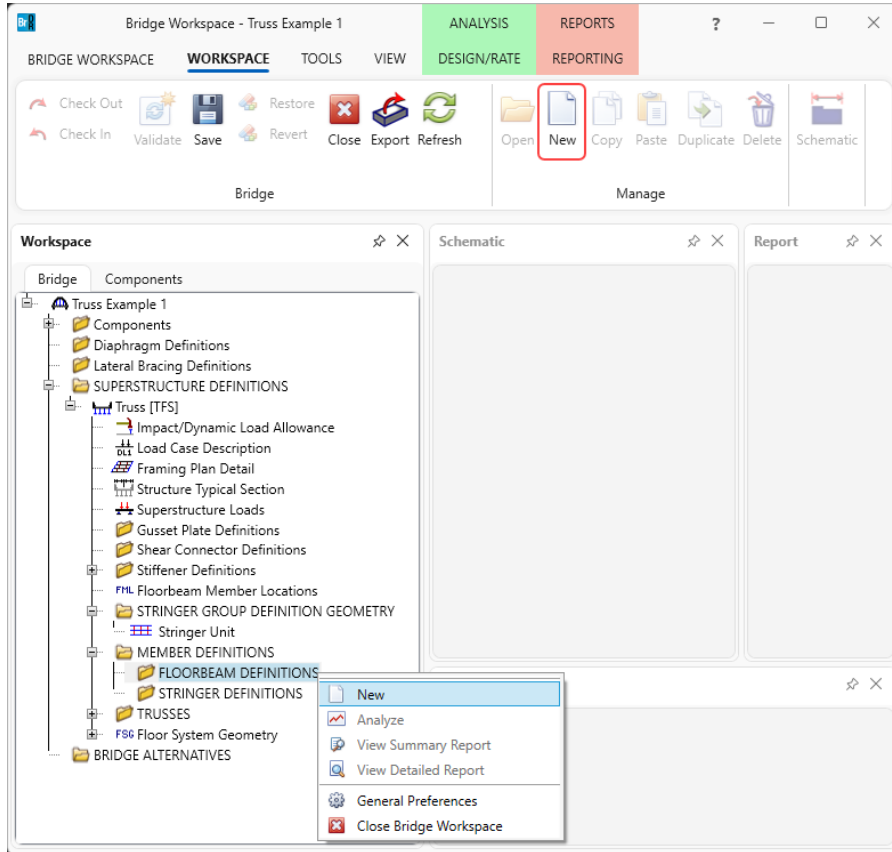

Select **Steel** as the **Material type** and **Rolled** for **Girder type** as shown below.

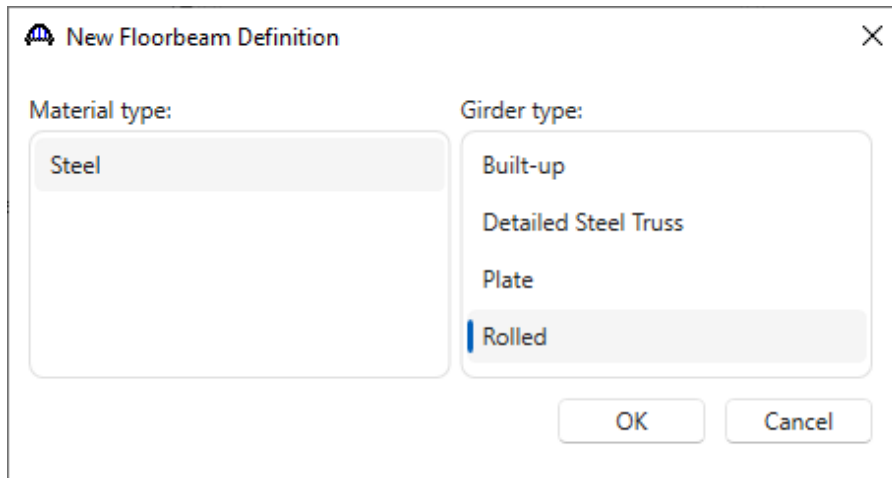

Click **OK** to close the window and create a new member definition.

T1 – Truss Floorbeam Stringer Example

The **Floorbeam Definition** window will open. Enter the data as shown below. Select **Schedule-based** as the **Floorbeam property input method**.

Floorbeam Definition

Name: Floorbeam Def

Description | Specs | Factors | Engine | Control options

Description:

Material type: Steel
Floorbeam type: Rolled
Default units: US Customary

Floorbeam property input method
 Schedule-based
 Cross-section based

Self load
Additional self load: kip/ft
Additional self load: %

Default rating method: LFR

Floorbeam length between main members

Span	Length (ft)
> 1	35.00

OK Apply Cancel

Click **OK** to apply the data and close the window.

Floorbeam Profile

Expand the **Floorbeam Def** node in the **Bridge Workspace** tree and double click on the **Floorbeam Profile** node in the **Bridge Workspace** tree to open the **Floorbeam Profile** window. Describe the floorbeam profile as shown below. The floorbeam is non-composite, so no data is required on the **Deck Profile** window.

Floorbeam Profile

Type: Rolled Shape

Shape | Top cover plate | Bottom cover plate

Shape	Start distance (ft)	Length (ft)	End distance (ft)	Material
> W 33x221	0.00	35.00	35.00	Grade 36

New Duplicate Delete

OK Apply Cancel

Click **OK** to apply the data and close the window.

T1 – Truss Floorbeam Stringer Example

Describing a Stringer Member Definition

Expand the **MEMBER DEFINITION** node in the **Bridge Workspace** tree and double click on the **STRINGER DEFINITIONS** node (or select **STRINGER DEFINITIONS** and click **New** from the **Manage** group of the **WORKSPACE** ribbon) to open the **New Stringer Definition** window as shown below.

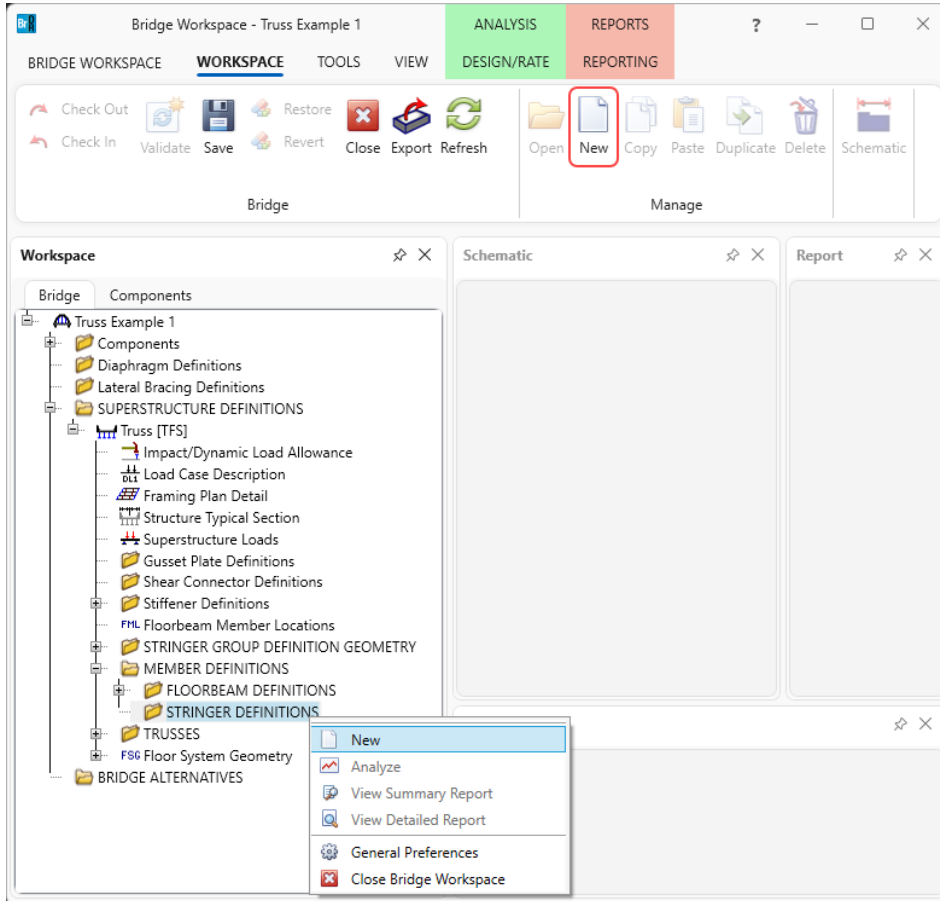

Select **Steel** as the **Material type** and **Rolled** for **Girder type** as shown below.

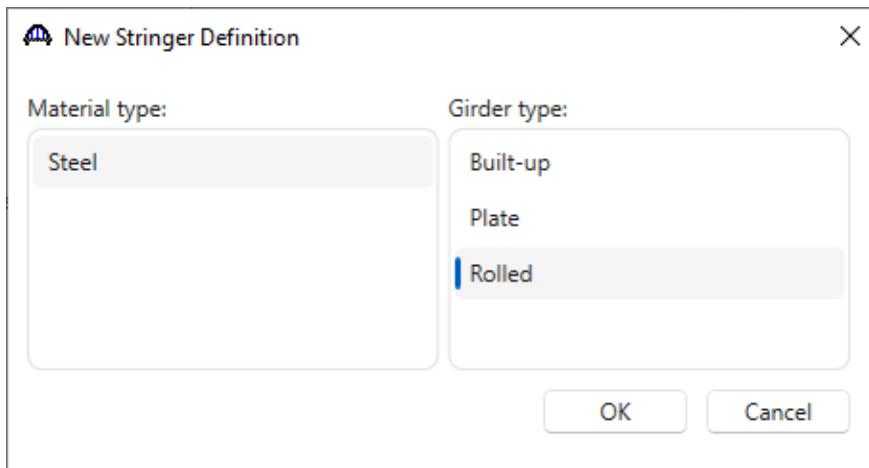

Click **OK** to close the window and create a new member definition.

T1 – Truss Floorbeam Stringer Example

The **Stringer Definition** window will open. Enter the data as shown below. Select **Schedule-based** as the **Stringer property input method**. Select the **Associate with stringer group definition** button so that the stringer span lengths will be populated based on the stringers span lengths specified in the **Stringer Group Definition Geometry** window.

Stringer Definition

Name: Interior Stringer

Description: [Empty]

Material type: Steel
Stringer type: Rolled
Default units: US Customary

Stringer property input method:
 Schedule-based
 Cross-section based

Self load:
Additional self load: [0] kip/ft
Additional self load: [0] %

Stringer span lengths:
 Associate with stringer group definition: Stringer Unit
 Enter stringer span lengths
Number of spans: [1]

Span	Length (ft)	Cantilever span
1	18.3333	<input type="checkbox"/>

Default rating method: LFR

End bearing locations:
Left: [0] in
Right: [0] in

OK Apply Cancel

 Save time – associate the stringer span lengths with the stringer group definition!

Click **OK** to apply the data and close the window.

T1 – Truss Floorbeam Stringer Example

Stringer Profile

Expand the **Interior Stringer** node in the **Bridge Workspace** tree and double click on the **Stringer Profile** node to open the **Stringer Profile** window. Describe the stringer profile as shown below. The stringer is non-composite, so no data is required on the **Deck Profile** window.

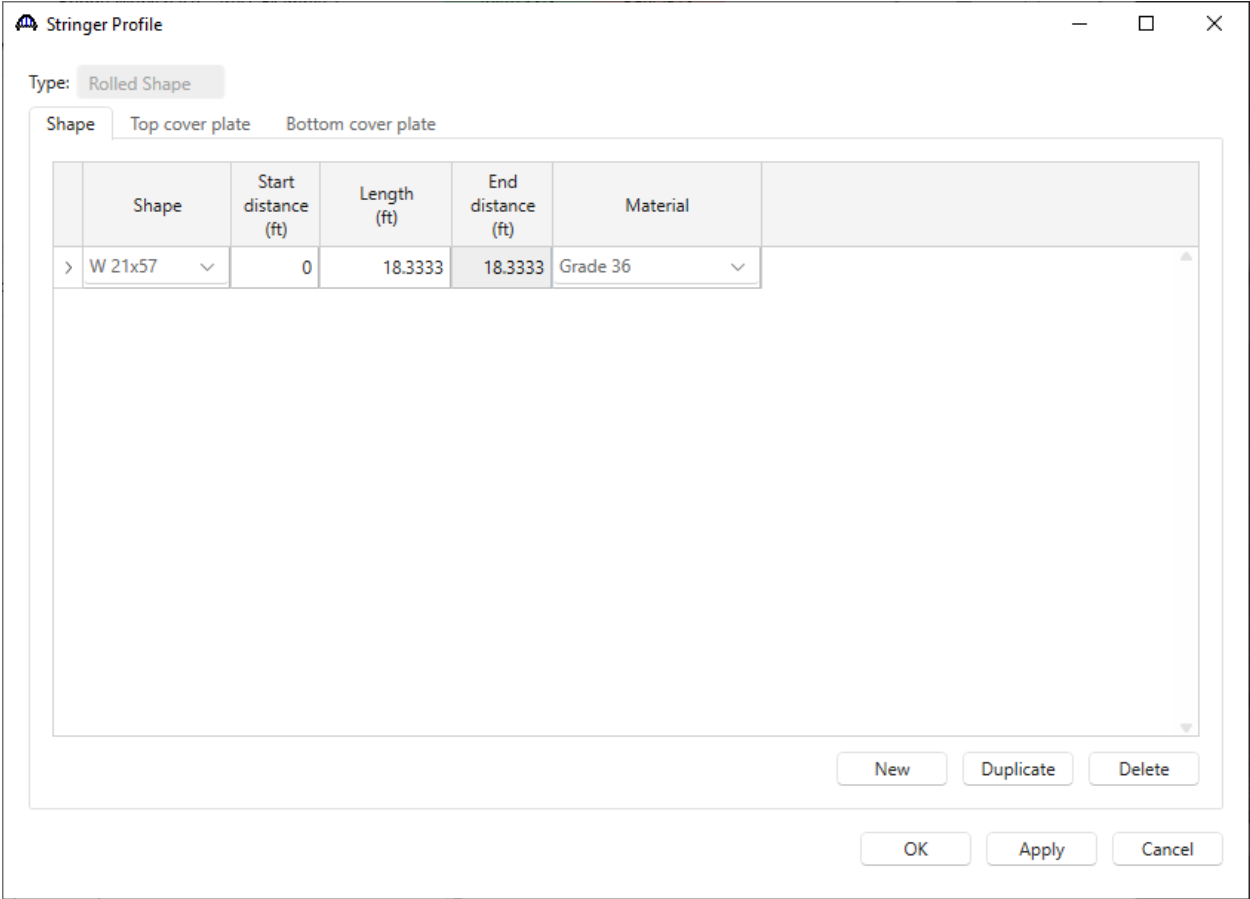

Click **OK** to apply the data and close the window.

T1 – Truss Floorbeam Stringer Example

Similarly, create a stringer definition to be used for the exterior stringers.

 Save time – associate the stringer span lengths with the stringer group definition!

Expand the **Exterior Stringer** node in the **Bridge Workspace** tree and double click on the **Stringer Profile** node in the **Bridge Workspace** tree to open the **Stringer Profile** window. Describe the stringer profile as shown below. The stringer is non-composite, so no data is required on the **Deck Profile** window.

Shape	Start distance (ft)	Length (ft)	End distance (ft)	Material
> W 16x57	0	18.3333	18.3333	Grade 36

T1 – Truss Floorbeam Stringer Example

The partially expanded **Bridge Workspace** tree is shown below.

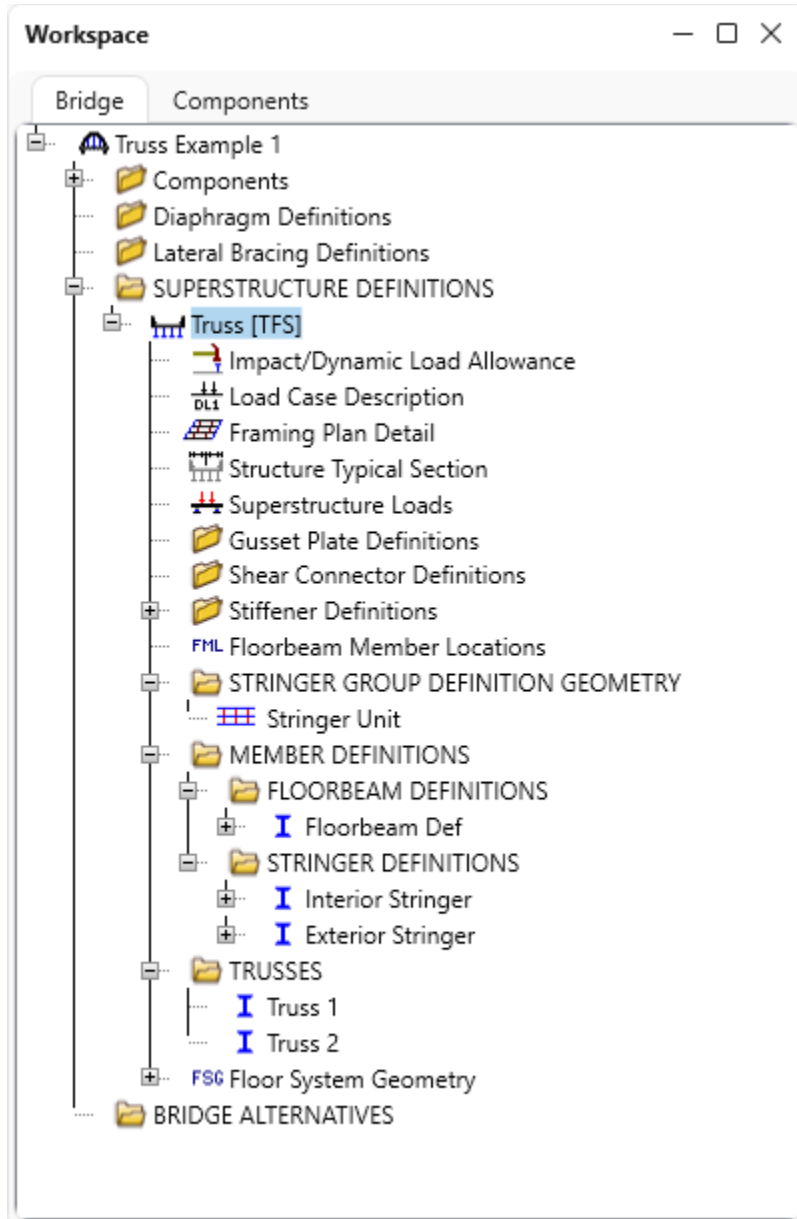

T1 – Truss Floorbeam Stringer Example

Trusses

Expand the **Trusses** node in the **Bridge Workspace** tree and double click on the **Truss 1** node to open the **Truss** window. Change the name of the truss to **North Truss**. Enter the text description as shown below.

The screenshot shows the 'Truss' window with the following details:

- Name:** North Truss
- Link with:** None
- Description Tab:**
 - Default rating method: LFR
 - Truss "North Truss"
 - Unit
 - Force kips
 - Length ft
 - Properties in
 - DefaultSysUnitType US
 - DefaultStructSteel "Truss Steel"
 - DefaultEndConnection Bolted
 - MaterialType
 - Steel = "Truss Steel"
 - Steel2 = "Grade 36"
 - MemberCrossSection
 - ChannelBox = Section1
 - Channels "C 15x55" Outward 13.0
 - Lacing Top
 - NonDetailed = Section2
 - 47.51 44.50 Steel 1125.6
 - Rolled = Section3
 - Beam "W 12x79"
 - ChannelBox = Section4
 - TopFlangePlate 22.0 0.5 Steel2
 - Channels "C 15x50" Outward 13.0
 - Lacing Bottom
 - ChannelBox = Section5
 - TopFlangePlate 22.0 0.5
 - LeftWebPlate 12.0 0.375
 - RightWebPlate 12.0 0.375
 - Channels "C 15x45" Outward 13.0
 - Connection Bolted 1.50
 - Lacing Bottom
 - Rolled = Section6
- Line number:** 44
- Buttons:** View member cross section, Verify, OK, Apply, Cancel

T1 – Truss Floorbeam Stringer Example

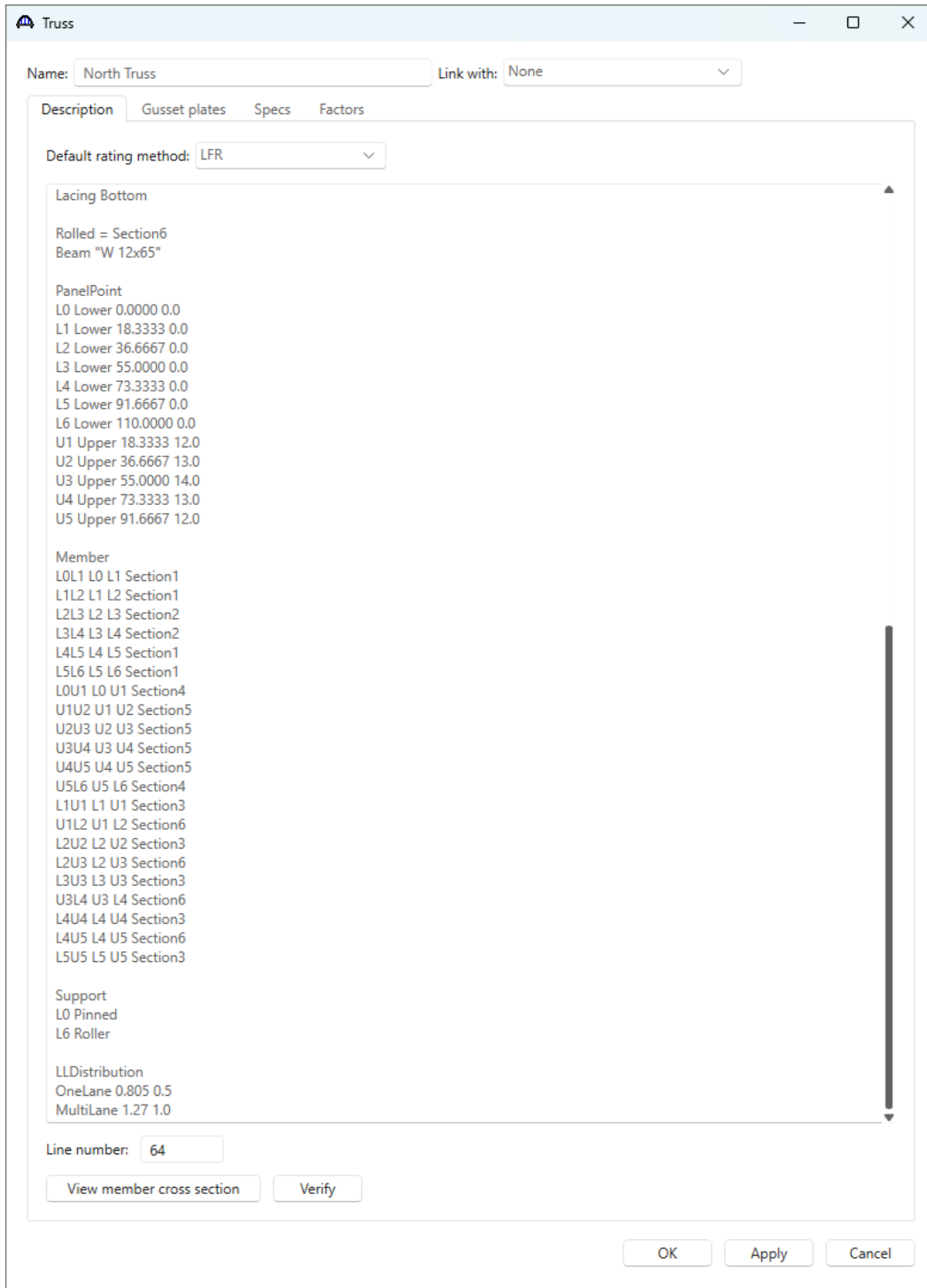

The **Verify** button reads the text description of the truss and verifies the syntax of the input commands.

T1 – Truss Floorbeam Stringer Example

“To save time, *copy the text below and enter in the Truss window for North Truss*”

Truss "North Truss"

Unit

Force kips

Length ft

Properties in

DefaultSysUnitType US

DefaultStructSteel "Truss Steel"

DefaultEndConnection

Bolted

MaterialType

Steel = "Truss Steel"

Steel2 = "Grade 36"

MemberCrossSection

ChannelBox = Section1

Channels "C 15x55" Outward 13.0

Lacing Top

NonDetailed = Section2

47.51 44.50 Steel 1125.6

Rolled = Section3

Beam "W 12x79"

ChannelBox = Section4

TopFlangePlate

22.0 0.5 Steel2

Channels "C 15x50" Outward 13.0

Lacing Bottom

ChannelBox = Section5

T1 – Truss Floorbeam Stringer Example

TopFlangePlate

22.0 0.5

LeftWebPlate

12.0 0.375

RightWebPlate

12.0 0.375

Channels "C 15x45" Outward 13.0

Connection Bolted 1.50

Lacing Bottom

Rolled = Section6

Beam "W 12x65"

PanelPoint

L0 Lower 0.0000 0.0

L1 Lower 18.3333 0.0

L2 Lower 36.6667 0.0

L3 Lower 55.0000 0.0

L4 Lower 73.3333 0.0

L5 Lower 91.6667 0.0

L6 Lower 110.0000 0.0

U1 Upper 18.3333 12.0

U2 Upper 36.6667 13.0

U3 Upper 55.0000 14.0

U4 Upper 73.3333 13.0

U5 Upper 91.6667 12.0

Member

L0L1 L0 L1 Section1

L1L2 L1 L2 Section1

L2L3 L2 L3 Section2

L3L4 L3 L4 Section2

L4L5 L4 L5 Section1

L5L6 L5 L6 Section1

L0U1 L0 U1 Section4

U1U2 U1 U2 Section5

U2U3 U2 U3 Section5

T1 – Truss Floorbeam Stringer Example

U3U4 U3 U4 Section5

U4U5 U4 U5 Section5

U5L6 U5 L6 Section4

L1U1 L1 U1 Section3

U1L2 U1 L2 Section6

L2U2 L2 U2 Section3

L2U3 L2 U3 Section6

L3U3 L3 U3 Section3

U3L4 U3 L4 Section6

L4U4 L4 U4 Section3

L4U5 L4 U5 Section6

L5U5 L5 U5 Section3

Support

L0 Pinned

L6 Roller

LLDistribution

OneLane 0.805 0.5

MultiLane 1.27 1.0

The following is a copy of the truss definition described using the BrDR **Truss Command Language**. A description of the command language and its syntax is available by opening the BrDR help for the Truss window.

Some of the commands are described in detail below. The name of the command is shown in bold text.

Command	Comments
Truss "North Truss"	
Unit Force kips Length ft Properties in	
DefaultSysUnitType US	
DefaultStructSteel "Truss Steel"	The steel material 'Truss Steel' from the BrDR BWS will be used as the default steel material if a steel material is not entered in later commands. The

T1 – Truss Floorbeam Stringer Example

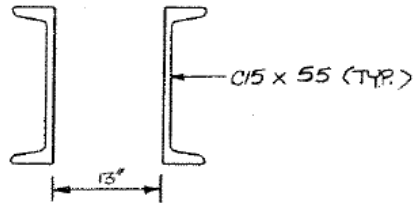
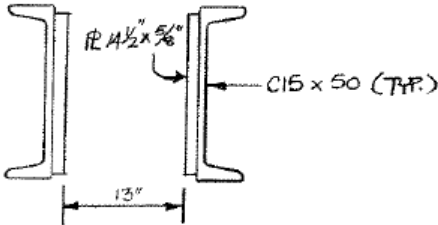
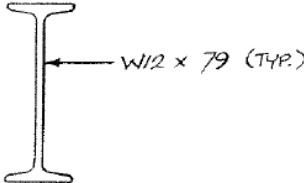
	double quotations around "Truss Steel" indicate that Truss Steel is defined in the BrDR BWS.
DefaultEndConnection Bolted	Used to determine the effective length factor K
MaterialType Steel = "Truss Steel" Steel2 = "Grade 36"	Wherever 'Steel' appears in later commands, the properties from the 'Truss Steel' in the BWS will be used. This command is a shortcut way to specify a steel material. This is useful for some of the steel materials in the BrDR Library whose names are lengthy.
MemberCrossSection ChannelBox = Section1 Channels "C 15x55" Outward 13.0 Lacing Top	 <p>The diagram shows two C 15x55 channels laced together. A dimension line indicates a spacing of 13 inches between the channels. The label 'C 15 x 55 (TYP.)' points to one of the channels.</p>
NonDetailed = Section2 47.51 44.50 Steel 1125.6	 <p>The diagram shows a C 15x50 channel with a 13 inch spacing. A plate labeled 'PL 4 1/2 x 5/16' is attached to the web. The label 'C 15 x 50 (TYP.)' points to the channel.</p> <p>Entered as a NonDetailed section instead of describing each plate. Only the gross, net area and moment of inertia of the section need to be entered in this command.</p>
Rolled = Section3 Beam "W 12x79"	 <p>The diagram shows a single W 12 x 79 beam. The label 'W 12 x 79 (TYP.)' points to the beam.</p>

T1 – Truss Floorbeam Stringer Example

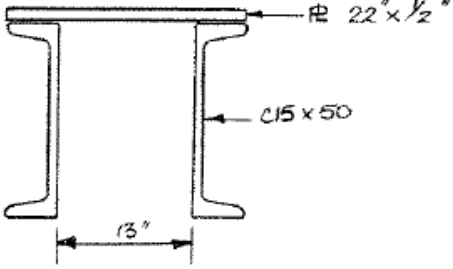
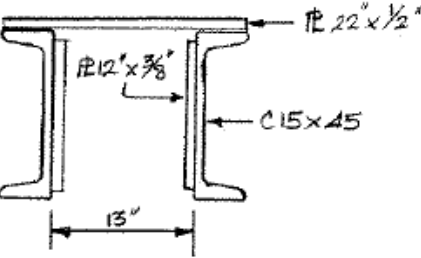
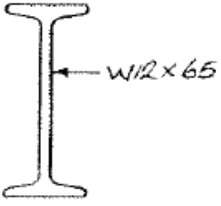
<p>ChannelBox = Section4 TopFlangePlate 22.0 0.5 Steel2 Channels "C 15x50" Outward 13.0 Lacing Bottom</p>	 <p>The top cover plate uses 'Steel2' instead of the default steel.</p>
<p>ChannelBox = Section5 TopFlangePlate 22.0 0.5 LeftWebPlate 12.0 0.375 RightWebPlate 12.0 0.375 Channels "C 15x45" Outward 13.0 Connection Bolted 1.50 Lacing Bottom</p>	 <p>1.50 in² will be deducted from the gross area for the connection holes.</p>
<p>Rolled = Section6 Beam "W 12x65"</p>	
<p>PanelPoint L0 Lower 0.0000 0.0 L1 Lower 18.3333 0.0 L2 Lower 36.6667 0.0 L3 Lower 55.0000 0.0 L4 Lower 73.3333 0.0 L5 Lower 91.6667 0.0 L6 Lower 110.0000 0.0 U1 Upper 18.3333 12.0 U2 Upper 36.6667 13.0 U3 Upper 55.0000 14.0 U4 Upper 73.3333 13.0 U5 Upper 91.6667 12.0</p>	

T1 – Truss Floorbeam Stringer Example

<p>Member</p> <p>L0L1 L0 L1 Section1 L1L2 L1 L2 Section1 L2L3 L2 L3 Section2 L3L4 L3 L4 Section2 L4L5 L4 L5 Section1 L5L6 L5 L6 Section1 L0U1 L0 U1 Section4 U1U2 U1 U2 Section5 U2U3 U2 U3 Section5 U3U4 U3 U4 Section5 U4U5 U4 U5 Section5 U5L6 U5 L6 Section4 L1U1 L1 U1 Section3 U1L2 U1 L2 Section6 L2U2 L2 U2 Section3 L2U3 L2 U3 Section6 L3U3 L3 U3 Section3 U3L4 U3 L4 Section6 L4U4 L4 U4 Section3 L4U5 L4 U5 Section6 L5U5 L5 U5 Section3</p>	<p>Members are identified by the panel points that they connect, and cross sections are assigned to the members in this command.</p>
<p>Support</p> <p>L0 Pinned L6 Roller</p>	
<p>LLDistribution</p> <p>OneLane 0.805 0.5 MultiLane 1.27 1.0</p>	<p>Lane distribution factors</p>

T1 – Truss Floorbeam Stringer Example

Schematic - Truss

While **North Truss** is selected in the **Bridge Workspace** tree, open the schematic for the truss by selecting the **Schematic** button on the **WORKSPACE** ribbon (or right click on **North Truss** and select **Schematic** from the menu).

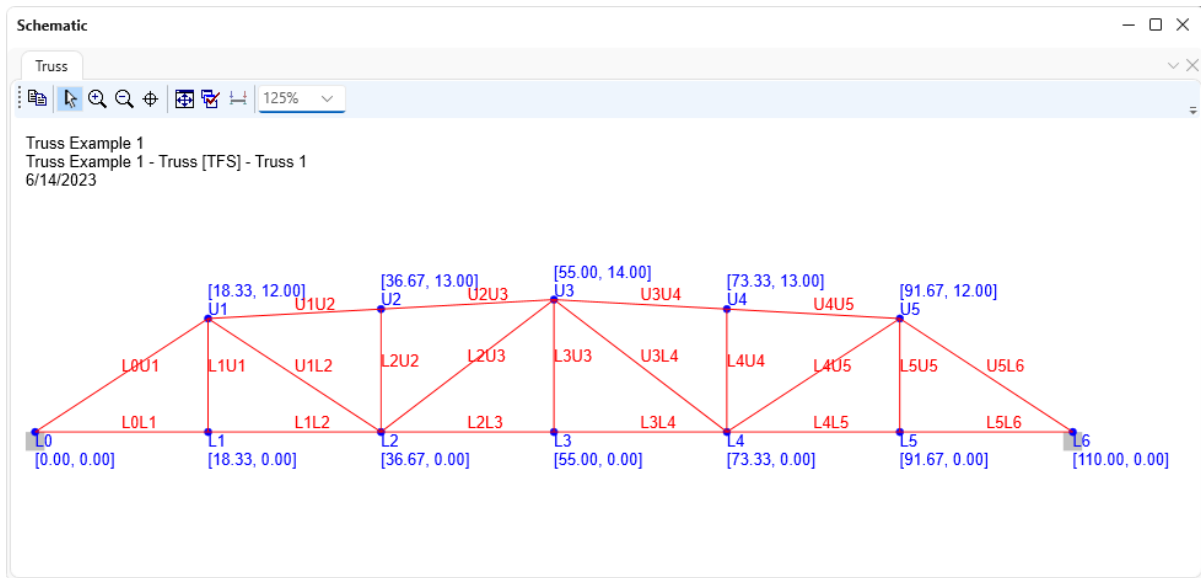

If floorbeams and stringers are described, BrDR will be able to compute the dead load of the floor system and apply it to the truss during the truss analysis.

Floor System Geometry

Double click on the **Floor System Geometry** node in the **Bridge Workspace** tree to open the **Floor System Geometry** window. Enter data as shown below. The total number of stringers in this structure is 42 since there are 6 stringer units and each unit contains 7 stringers. The location of these stringers along the length of the structure and length of each stringer is unknown. The stringer members in the structure are all located at the beginning of the structure and don't have any length to them until a stringer group definition is assigned to the stringer units. The stringer group definition defines the stringer span lengths. Assigning stringer group definitions to the stringer units also locates the stringer members along the length of the structure. Click F1 while this window is open to view examples illustrating the method for assigning stringer group definitions to stringer units.

T1 – Truss Floorbeam Stringer Example

Floor System Geometry

Include floorbeams in unit references

Stringer unit number	Stringer group definition	Unit referenced from left end of superstructure or end of previous unit	Distance to stringer group definition workpoint (ft)	Mirror group definition	Include in analysis
Unit 1	Stringer Unit	Left end of structure	0.00	None	<input type="checkbox"/>
Unit 2	Stringer Unit	End of Previous Unit	0.00	None	<input type="checkbox"/>
Unit 3	Stringer Unit	End of Previous Unit	0.00	None	<input type="checkbox"/>
Unit 4	Stringer Unit	End of Previous Unit	0.00	None	<input type="checkbox"/>
Unit 5	Stringer Unit	End of Previous Unit	0.00	None	<input type="checkbox"/>
> Unit 6	Stringer Unit	End of Previous Unit	0.00	None	<input type="checkbox"/>

OK Apply Cancel

T1 – Truss Floorbeam Stringer Example

Stringer Unit Layout Wizard

Expand **Floor System Geometry**. While **STRINGER UNIT LAYOUT** is selected on the **Bridge Workspace** tree, click the **Wizard** button from the **Bridge** group of the **TOOLS** ribbon to open the **Stringer Unit Layout Wizard** as shown below.

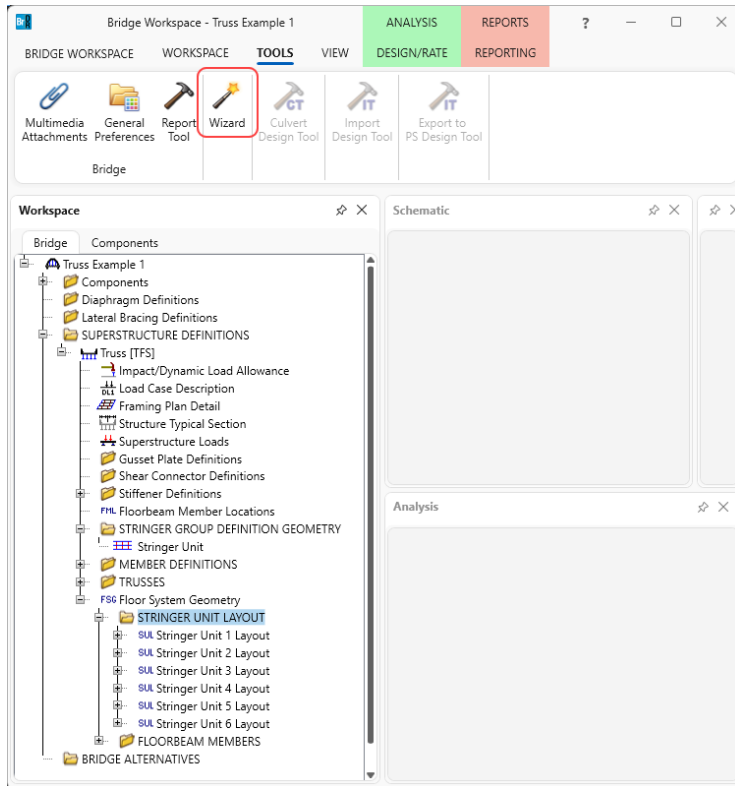

T1 – Truss Floorbeam Stringer Example

Enter a name for the new template as shown below and click the **Next** button as shown below.

Stringer Unit Layout Wizard

Welcome to the stringer unit layout wizard

This wizard helps you create stringer member alternatives quickly using stringer group definition templates. Stringer group definition templates let you assign stringer definitions and stringer live load distribution factors to stringer members. These templates can be stored and re-used.

Select the stringer group definition to which this template applies: Stringer Unit

Enter a name for the new template: Template

This stringer group definition has been applied to the following stringer unit locations in the floor system geometry window:

Stringer unit	Stringer group definition	Mirrored status
> Unit 1	Stringer Unit	
Unit 2	Stringer Unit	
Unit 3	Stringer Unit	
Unit 4	Stringer Unit	
Unit 5	Stringer Unit	
Unit 6	Stringer Unit	

< Back Next > Cancel Help

Click on the **Generate stringer member alternative names** and click the **Next** button as shown below.

T1 – Truss Floorbeam Stringer Example

Click on the **Generate stringer member alternative names** button to automatically generate names based on the prefix selected. Select **Exterior Stringer** definition for Stringer 1 and Stringer 7 as shown. The updated window is shown below.

Stringer definitions

This screen allows you to create Stringer Member Alternatives and assign Stringer Definitions to these alternatives for all Stringer Members using the Stringer Group Definition picked on Page 1. After the Stringer Member Alternatives are created at the end of this wizard, you can change the Stringer Definitions assigned to the Stringer Member Alternatives by visiting the individual Stringer Member Alternative windows. Changing stringer definitions in the stringer member alternative window will not make corresponding changes in this template.

This wizard will generate names for the Stringer Member Alternatives for you or you can enter them yourself in the table below.

Prefix to use when generating Stringer Member Alternatives' names: Generate stringer member alternative names

Stringer member*	Existing stringer member alternative name	Existing stringer definition	Current stringer member alternative name	Current stringer definition
Stringer 1	Stringer 1 Alt	Exterior Stringer ▾	Stringer 1 Alt	Exterior Stringer ▾
Stringer 2	Stringer 2 Alt	Interior Stringer ▾	Stringer 2 Alt	Interior Stringer ▾
Stringer 3	Stringer 3 Alt	Interior Stringer ▾	Stringer 3 Alt	Interior Stringer ▾
Stringer 4	Stringer 4 Alt	Interior Stringer ▾	Stringer 4 Alt	Interior Stringer ▾
Stringer 5	Stringer 5 Alt	Interior Stringer ▾	Stringer 5 Alt	Interior Stringer ▾
Stringer 6	Stringer 6 Alt	Interior Stringer ▾	Stringer 6 Alt	Interior Stringer ▾
> Stringer 7	Stringer 7 Alt	Exterior Stringer ▾	Stringer 7 Alt	Exterior Stringer ▾

*Stringer members in this table are listed from left to right in the structure typical section.

< Back
Next >
Cancel
Help

Click on the **Next** button.

T1 – Truss Floorbeam Stringer Example

Select each stringer and use the **Compute from typical section** button to compute the stringer live load distribution factors. Uncheck the Allow distribution factors to be used for compute effects of permit loads with routine traffic button and click Apply. Repeat this for each stringer. Once the values are computed for all the stringers, click the **Next** button.

Stringer Unit Layout Wizard

Live load distribution factors
This screen allows you to assign live load distribution factors to the Stringer Member Alternatives that will be generated by this wizard

Stringer: Stringer 1

Standard

Allow distribution factors to be used to compute effects of permit loads with routine traffic

Lanes loaded	Distribution factor (wheels)			
	Shear	Shear at supports	Moment	Deflection
> 1 Lane	0.9090909	0.75	0.9090909	0.2857143
Multi-lane	0.9090909	0.75	0.9090909	0.5714286

Lrfd

Allow distribution factors to be used to compute effects of permit loads with routine traffic

Action: Moment

Start distance (ft)	Length (ft)	End distance (ft)	Distribution factor (lanes)	
			1 lane	Multi-lane

< Back Next > Cancel Help

Stringer Unit Layout Wizard

Live load distribution factors
This screen allows you to assign live load distribution factors to the Stringer Member Alternatives that will be generated by this wizard

Stringer: Stringer 2

Standard

Allow distribution factors to be used to compute effects of permit loads with routine traffic

Lanes loaded	Distribution factor (wheels)			
	Shear	Shear at supports	Moment	Deflection
> 1 Lane	0.7142857	1	0.7142857	0.2857143
Multi-lane	0.9090909	1	0.9090909	0.5714286

T1 – Truss Floorbeam Stringer Example

Stringer Unit Layout Wizard

Live load distribution factors
This screen allows you to assign live load distribution factors to the Stringer Member Alternatives that will be generated by this wizard

Stringer: Stringer 3

Standard

Allow distribution factors to be used to compute effects of permit loads with routine traffic

Lanes loaded	Distribution factor (wheels)			
	Shear	Shear at supports	Moment	Deflection
> 1 Lane	0.7142857	1	0.7142857	0.2857143
Multi-lane	0.9090909	1.2	0.9090909	0.5714286

Stringer Unit Layout Wizard

Live load distribution factors
This screen allows you to assign live load distribution factors to the Stringer Member Alternatives that will be generated by this wizard

Stringer: Stringer 4

Standard

Allow distribution factors to be used to compute effects of permit loads with routine traffic

Lanes loaded	Distribution factor (wheels)			
	Shear	Shear at supports	Moment	Deflection
> 1 Lane	0.7142857	1	0.7142857	0.2857143
Multi-lane	0.9090909	1.2	0.9090909	0.5714286

Stringer Unit Layout Wizard

Live load distribution factors
This screen allows you to assign live load distribution factors to the Stringer Member Alternatives that will be generated by this wizard

Stringer: Stringer 5

Standard

Allow distribution factors to be used to compute effects of permit loads with routine traffic

Lanes loaded	Distribution factor (wheels)			
	Shear	Shear at supports	Moment	Deflection
> 1 Lane	0.7142857	1	0.7142857	0.2857143
Multi-lane	0.9090909	1.2	0.9090909	0.5714286

T1 – Truss Floorbeam Stringer Example

Stringer Unit Layout Wizard

Live load distribution factors
This screen allows you to assign live load distribution factors to the Stringer Member Alternatives that will be generated by this wizard

Stringer: Stringer 6 Apply

Standard

Allow distribution factors to be used to compute effects of permit loads with routine traffic Compute from typical section

Lanes loaded	Distribution factor (wheels)			
	Shear	Shear at supports	Moment	Deflection
> 1 Lane	0.7142857	1	0.7142857	0.2857143
Multi-lane	0.9090909	1	0.9090909	0.5714286

Stringer Unit Layout Wizard

Live load distribution factors
This screen allows you to assign live load distribution factors to the Stringer Member Alternatives that will be generated by this wizard

Stringer: Stringer 7 Apply

Standard

Allow distribution factors to be used to compute effects of permit loads with routine traffic Compute from typical section

Lanes loaded	Distribution factor (wheels)			
	Shear	Shear at supports	Moment	Deflection
> 1 Lane	0.9090909	0.75	0.9090909	0.2857143
Multi-lane	0.9090909	0.75	0.9090909	0.5714286

Click the **Next** button.

T1 – Truss Floorbeam Stringer Example

Click the **Finish** button.

Stringer Unit Layout Wizard

Completing the stringer unit layout wizard

You have successfully completed the stringer unit layout wizard.

You have created a stringer group definition template named:

This template will be applied to the stringer members in the stringer units:

	Stringer unit	Stringer group definition	Mirrored status
>	Unit 1	Stringer Unit	<input type="checkbox"/>
	Unit 2	Stringer Unit	<input type="checkbox"/>
	Unit 3	Stringer Unit	<input type="checkbox"/>
	Unit 4	Stringer Unit	<input type="checkbox"/>
	Unit 5	Stringer Unit	<input type="checkbox"/>
	Unit 6	Stringer Unit	<input type="checkbox"/>

To close this wizard, save this template and create stringer member alternatives with these template properties, click finish.

To close this wizard and save this template without creating stringer member alternatives with these template properties, click finish later.

To close this wizard without saving this template or creating stringer member alternatives, click cancel.

< Back Finish later **Finish** Cancel Help

T1 – Truss Floorbeam Stringer Example

Floorbeam Member Alternative Wizard

Similarly, open the **Floorbeam Member Alternative Wizard** by selecting the **Wizard** button from the **Bridge** group of the **TOOLS** menu while selecting the **FLOORBEAM MEMBERS** node in the **Bridge Workspace** tree as shown below.

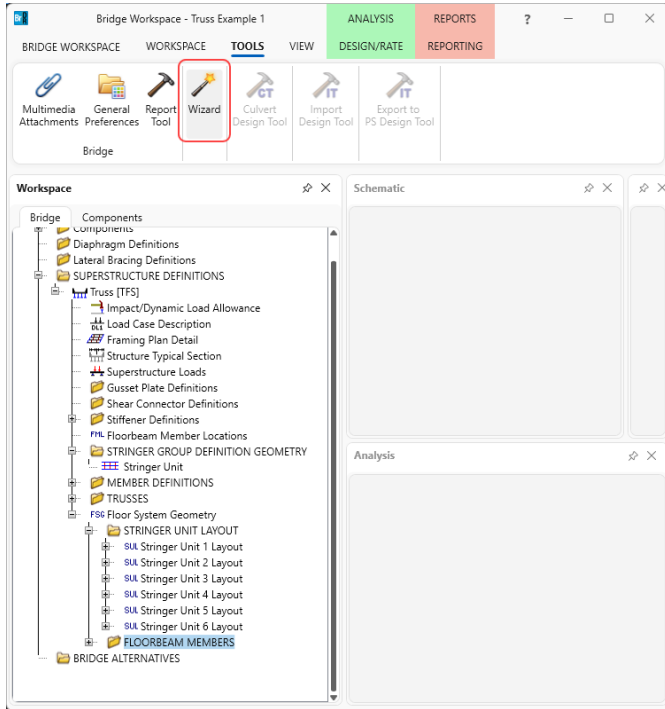

Click on the **Generate floorbeam member alternative names** button to create the floorbeam member alternative names as shown below.

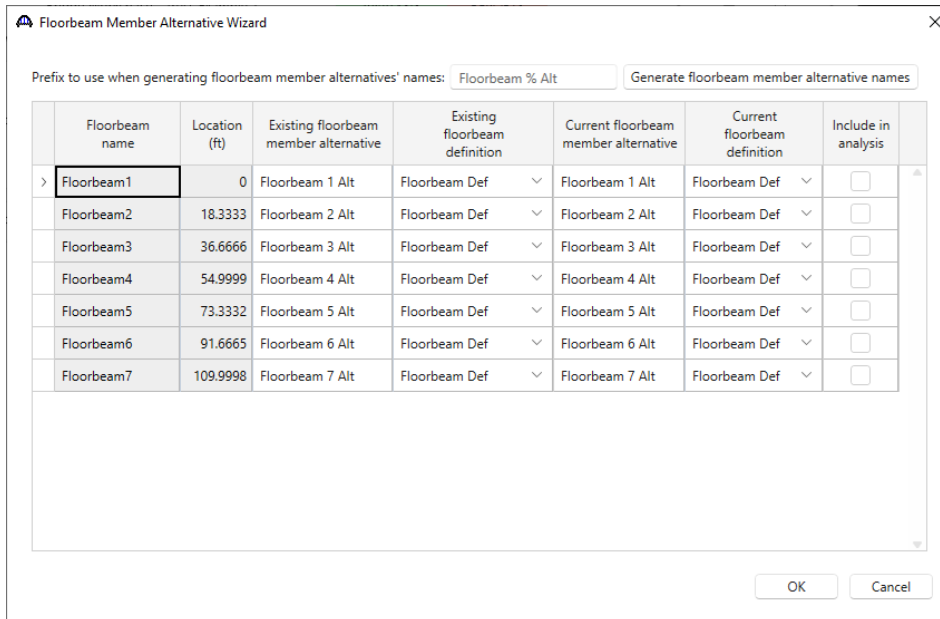

Click **OK** to apply the data and close the window.

T1 – Truss Floorbeam Stringer Example

Schematic – Framing Plan Detail

While the **Framing Plan Detail** is selected in the **Bridge Workspace** tree, open the schematic for the framing plan by selecting the **Schematic** button on the **WORKSPACE** ribbon (or right click on **Framing Plan Detail** and select **Schematic** from the menu).

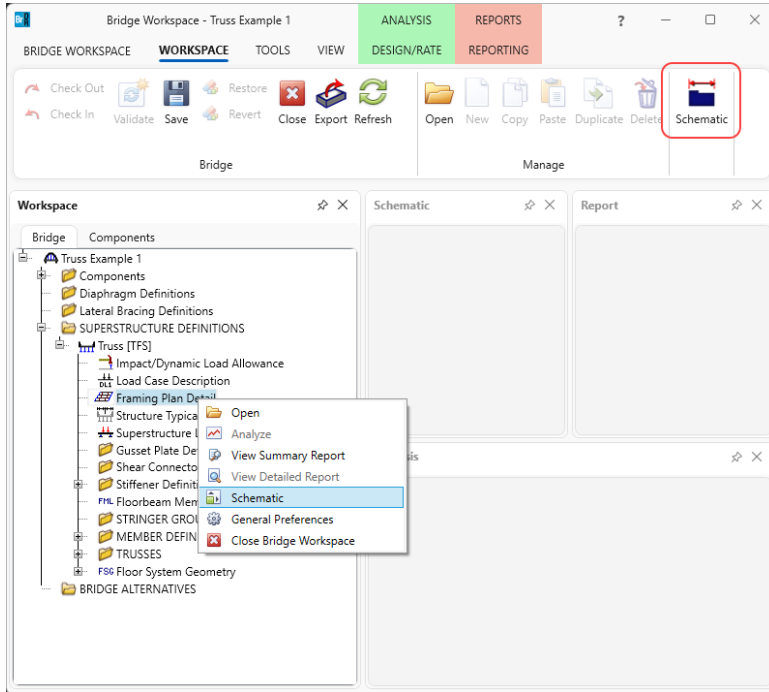

The schematic for the framing plan now appears as shown below.

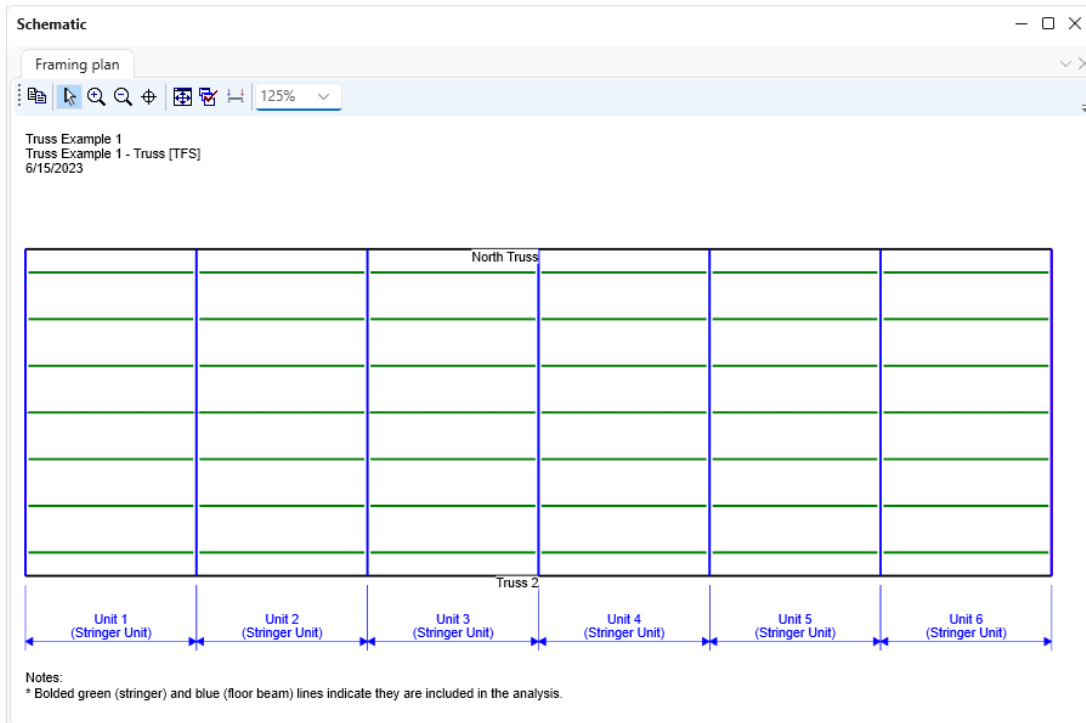

T1 – Truss Floorbeam Stringer Example

Schematic – Structure Typical Section

While then **Structure Typical Section** is selected in the **Bridge Workspace** tree, open the schematic for the structure typical section by selecting the **Schematic** button on the **WORKSPACE** ribbon (or right click on **Structure Typical Section** in the **Bridge Workspace** and select **Schematic** from the menu).

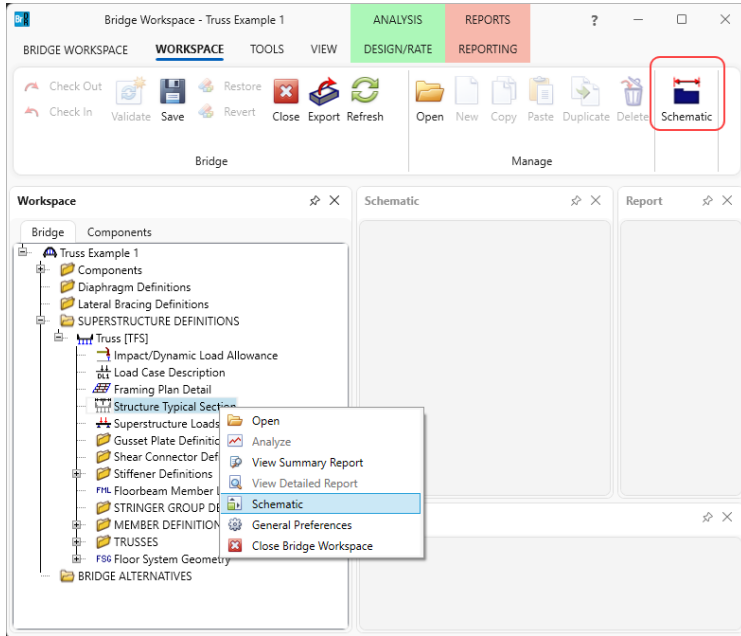

The schematic for the structure typical section now appears as shown below.

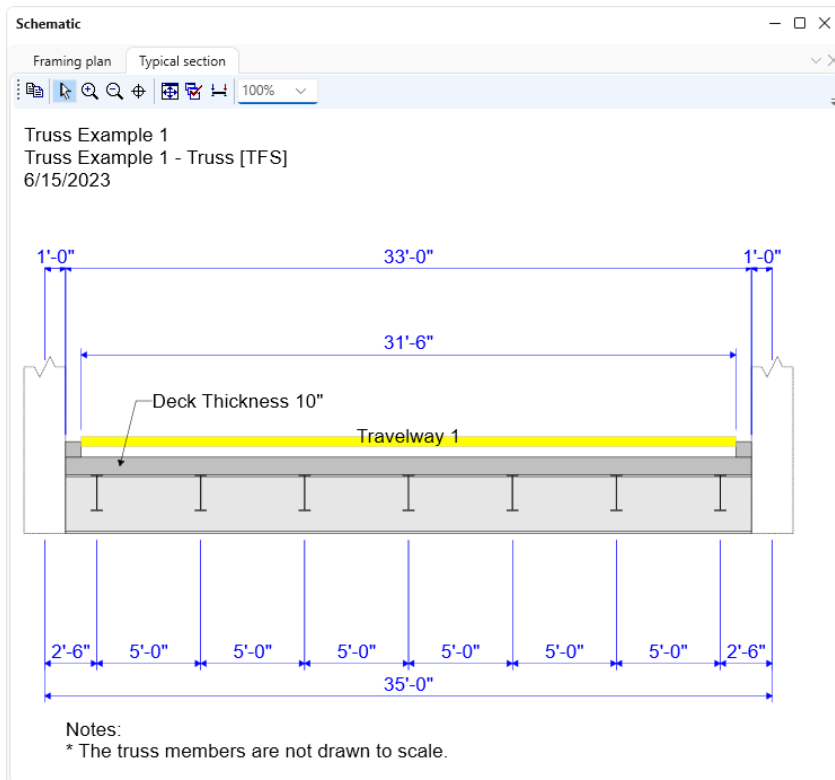

T1 – Truss Floorbeam Stringer Example

LFR Analysis

To perform a rating on the North Truss, select the **North Truss** in the **Bridge Workspace** tree and click the **Analysis Settings** button on the **Analysis** group of the **DESIGN/RATE** ribbon. The window shown below opens.

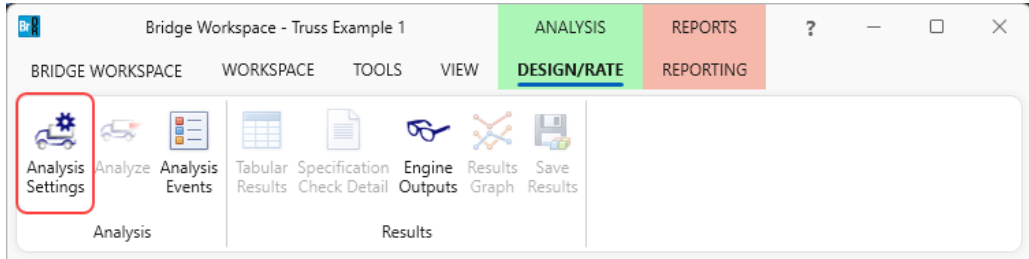

Select vehicle **HS 20-44** under **Inventory** and **Operating** as shown below.

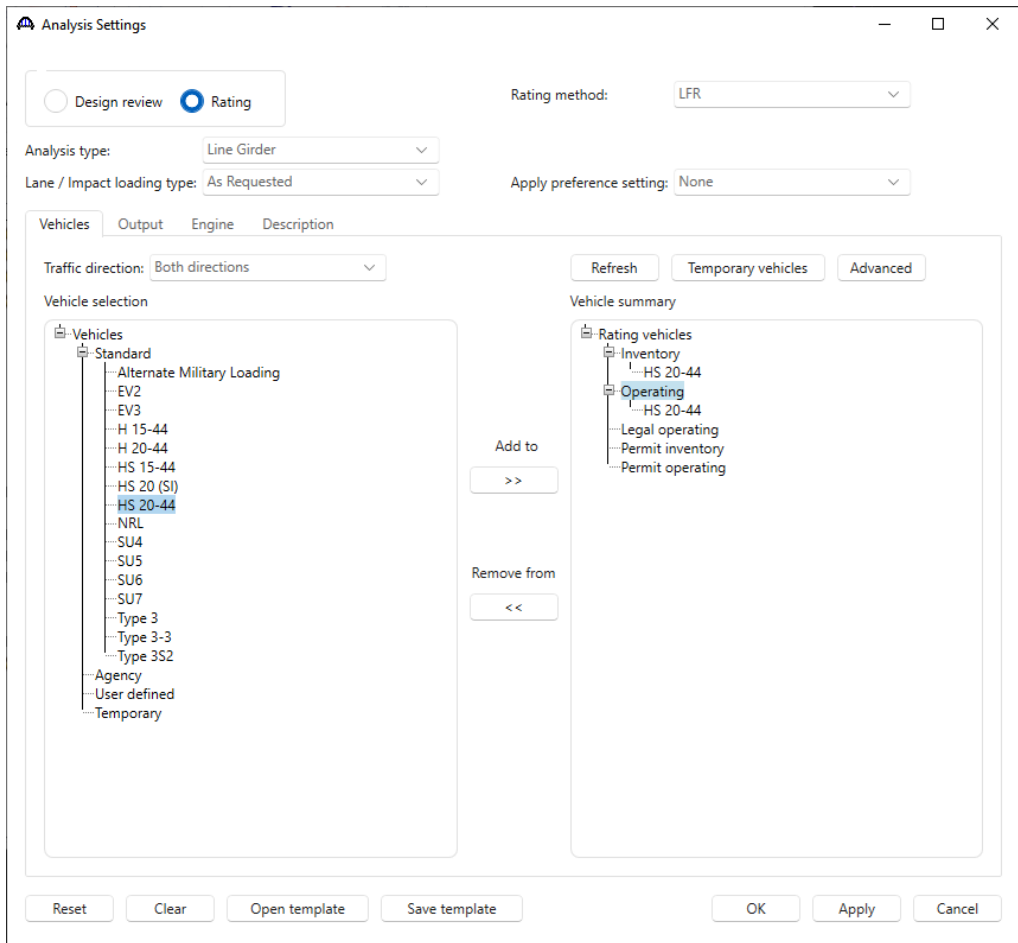

T1 – Truss Floorbeam Stringer Example

Navigate to the **Output** tab and apply the settings as shown below.

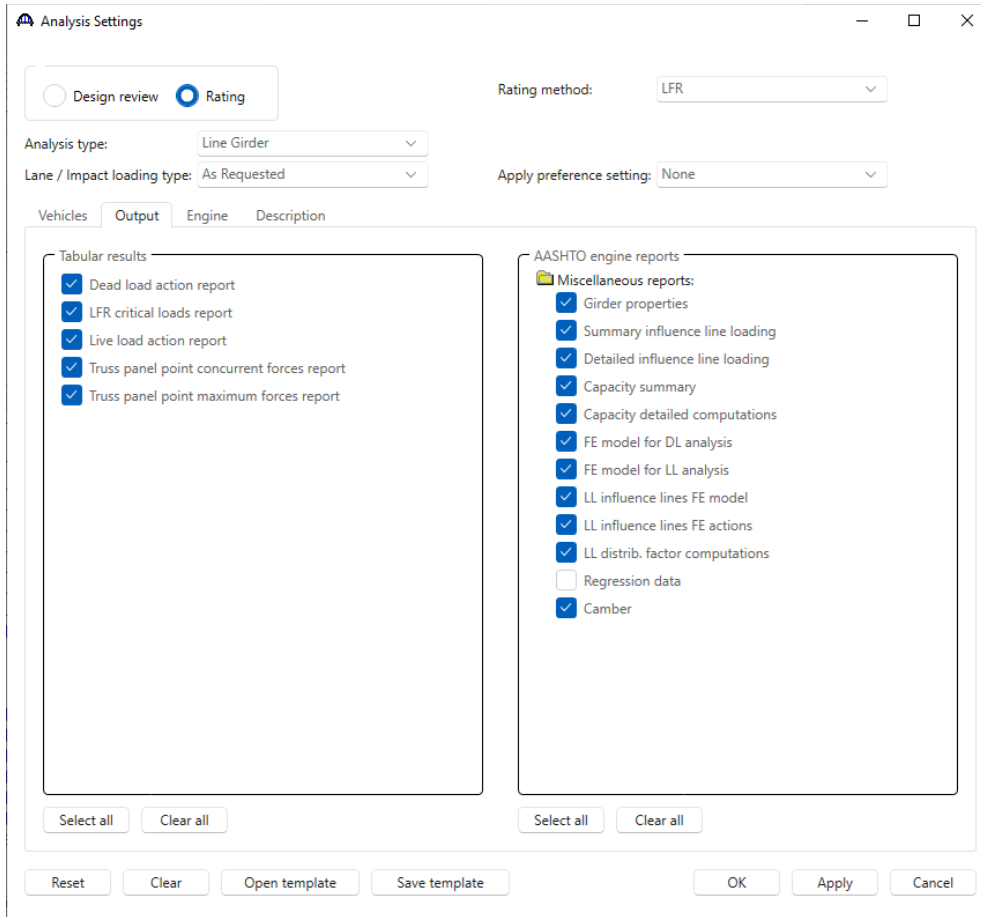

Click **OK** to apply the analysis settings and close the window.

Select **North Truss** in the **Bridge Workspace** tree and click the **Analyze** button from the **Analysis** group of the **DESIGN/RATE** ribbon to perform the rating.

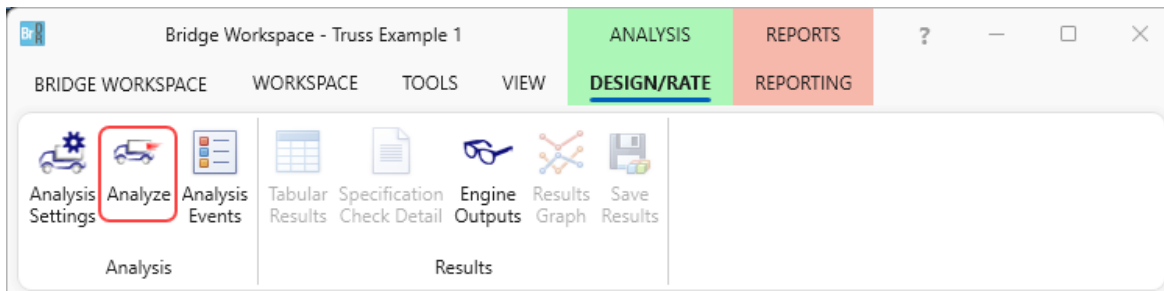

T1 – Truss Floorbeam Stringer Example

Tabular Results

When the rating is finished results can be reviewed by selecting the **North Truss** member in the **Bridge Workspace** tree and clicking the **Tabular Results** button on the **Results** group of the ribbon.

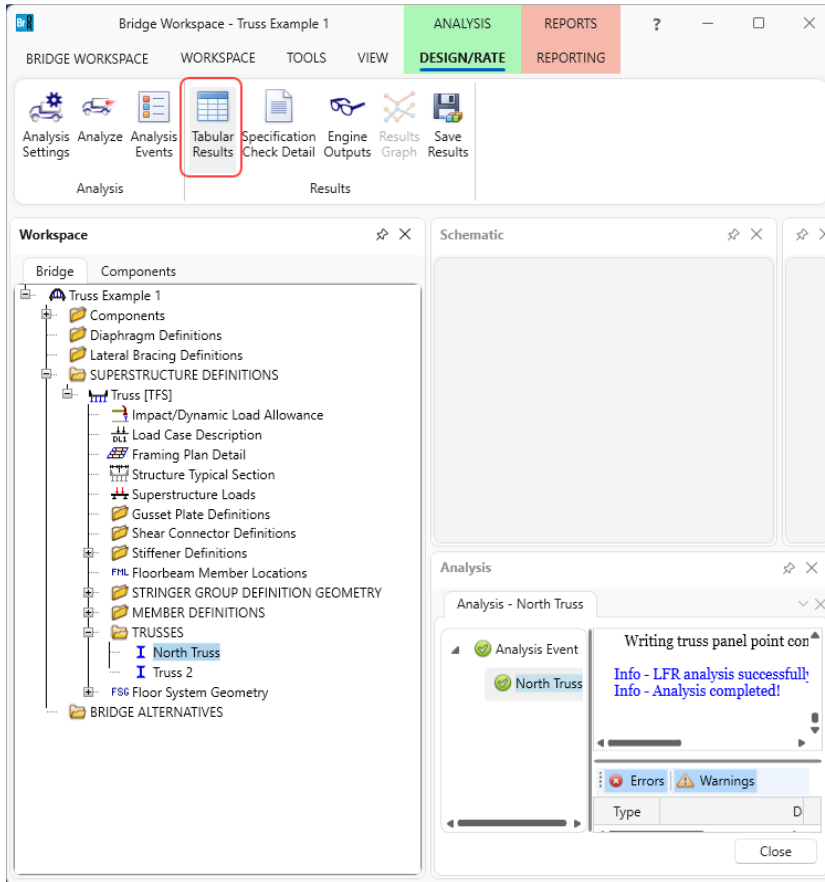

The window shown below will open.

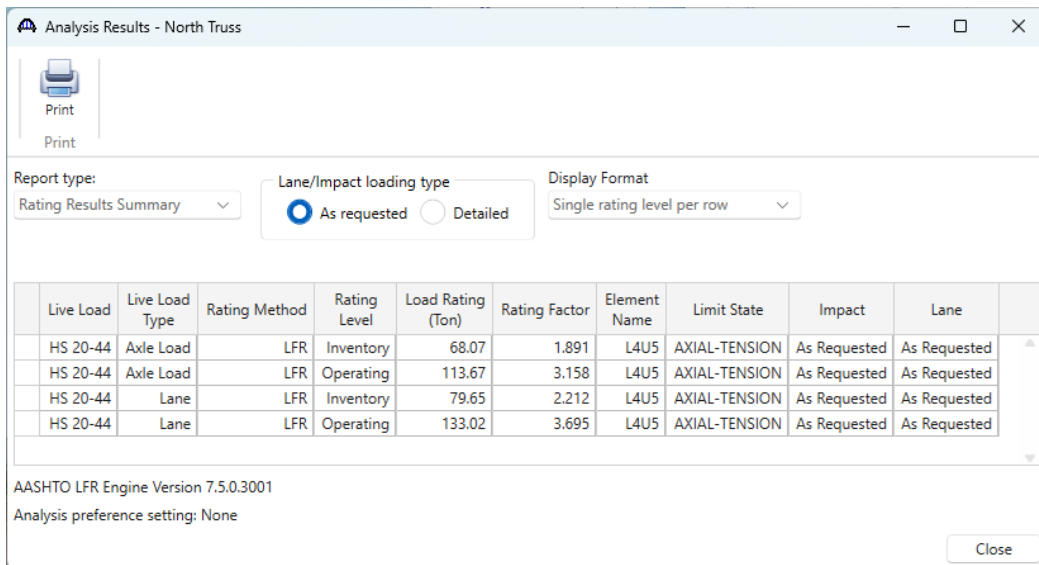

T1 – Truss Floorbeam Stringer Example

Engine Outputs

After the analysis, the output files can be viewed by clicking the **Engine Outputs** button on the **Results** group of the ribbon.

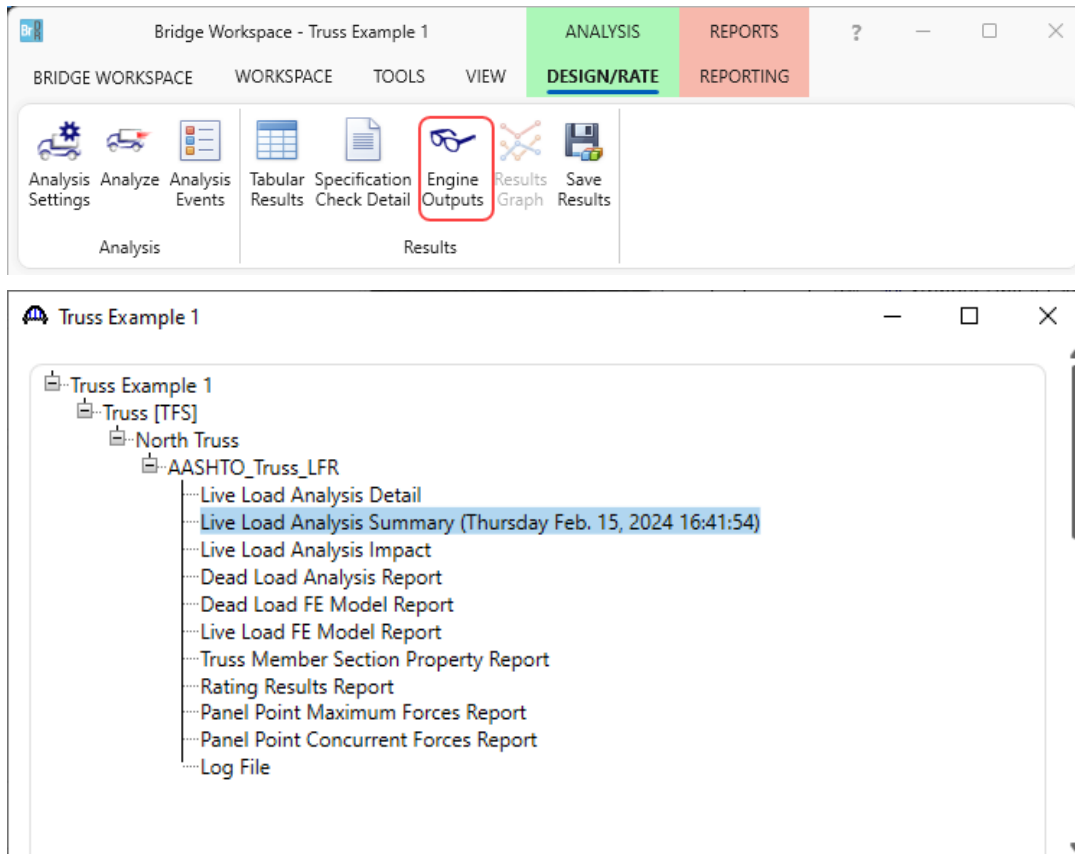

The **Live Load Analysis Summary** contains data related to the live loading of the truss influence lines. The **Dead Load Analysis Report** contains the truss finite element model and dead load analysis. The **Truss Member Section Property Report** contains data related to the computed and user input truss member section properties. The **Rating Results Report** contains the rating results for the truss. The **Log file** is the analysis log produced when the analysis is run. This file may contain errors and warnings that should be reviewed.

T1 – Truss Floorbeam Stringer Example

A portion of the **Rating Results** output report is shown below.

Rating Results Report

Bridge ID :TrussExample1
 Bridge : Truss Example 1
 StructDef: Truss(TFS)
 User : bridge
 Date : Friday, June 21, 2024
 File : RatingResults.XML
 Analysis Preference Setting : None

NBI Structure ID :Truss Example 1
 Bridge Alt :
 Member : NorthTruss

Overall Load Factor Rating Summary

Live Load	Live Load Type	Inv Element	Inv RF	Inv Capacity (Ton)	Opr Element	Opr RF	Opr Capacity (Ton)	Legal Opr Element	Legal Opr RF	Legal Opr Capacity (Ton)	Permit Inv Element	Permit Inv RF	Permit Inv Capacity (Ton)	Permit Opr Element	Permit Opr RF	Permit Opr Capacity (Ton)	Impact	Lane
HS 20-44 - Lane	Design Lane	L4U5	2.212	79.65	L4U5	3.695	133.02										As Requested	As Requested
HS 20-44 - Lane	Design Lane	L4U5	2.212	79.65	L4U5	3.695	133.02										With Impact	Multi-Lane
HS 20-44 - Truck	Design Truck	L4U5	1.891	68.07	L4U5	3.158	113.67										As Requested	As Requested
HS 20-44 - Truck	Design Truck	L4U5	1.891	68.07	L4U5	3.158	113.67										With Impact	Multi-Lane

Live Load: HS 20-44 - Lane (Design Lane)

Detailed Truss Member Rating Results

LL Scale Factor = 1.00
 Adjacent Vehicle LL Factor = 0.00
Inventory:
 A1 = 1.30, A2 = 2.17
Operating:
 A1 = 1.30, A2 = 1.30
 Note: Rating factor is outputted as 99.00 when it is greater than 99

Member	Truss Element	DL Force (kip)	LL Force		Capacity		Adj. LL		One Lane LLDF	Multi Lane LLDF	Inv RF	Opr RF	Legal Opr RF	Permit Inv RF	Permit Opr RF
			Comp. (kip)	Tens. (kip)	Comp. (kip)	Tens. (kip)	Comp. (kip)	Tens. (kip)							
L0L1	Lower-Chord	207.76		67.73	1.21		969.60			1.270	3.089	5.158			
L1L2	Lower-Chord	207.76		67.73	1.21		969.60			1.270	3.089	5.158			
L2L3	Lower-Chord	322.31		104.50	1.21		1335.00			1.270	2.621	4.378			
L3L4	Lower-Chord	322.31		104.50	1.21		1335.00			1.270	2.621	4.378			
L4L5	Lower-Chord	207.76		67.73	1.21		969.60			1.270	3.089	5.158			
L5L6	Lower-Chord	207.76		67.73	1.21		969.60			1.270	3.089	5.158			

T1 – Truss Floorbeam Stringer Example

Truss Line Superstructures

Open the bridge file (.xml) provided with this tutorial.

The **Bridge Workspace tree** for a **truss-floorbeam-stringer line** superstructure definition is shown below.

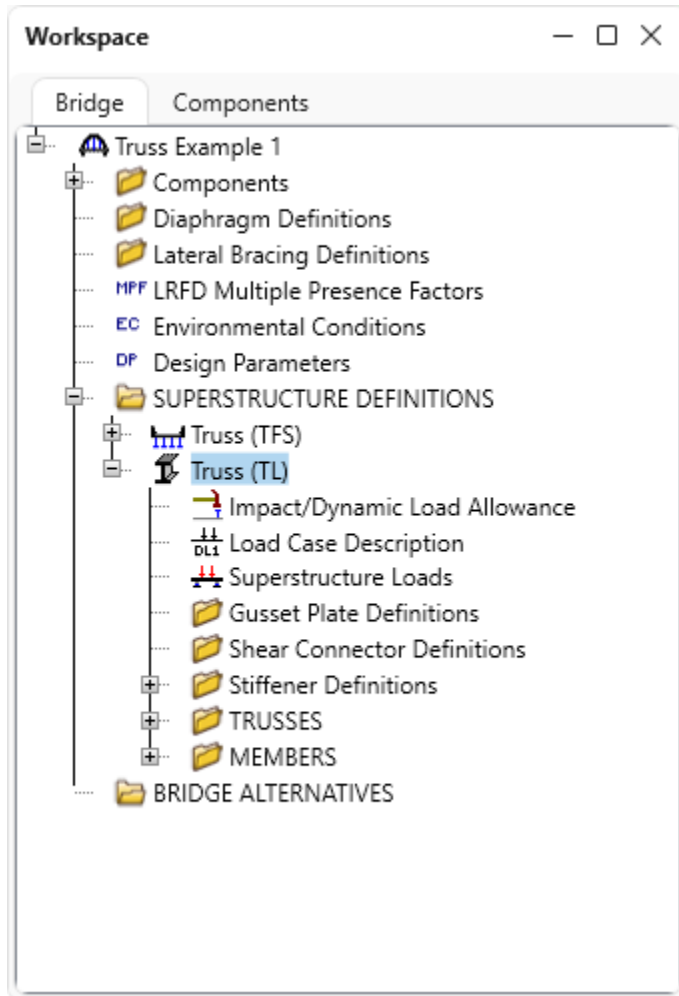

In a truss line superstructure definition, the relationship between the truss and floor system is not defined. Therefore, the floor system dead loads that act on the truss needs to be entered by the user. These loads are computed as follows.

Deck Dead Load on Truss

$$\text{Deck DL} = 10''/12 * 33.0' * 0.150\text{pcf} = 4.125 \text{ kip/ft}$$

$$\text{L0, L6: } 18.33'/2 * 4.125 \text{ k/ft} / 2 \text{ trusses} = 18.90 \text{ kips}$$

$$\text{L1, L2, L3, L4, L5: } 18.33' * 4.125 \text{ k/ft} / 2 \text{ trusses} = 37.81 \text{ kips}$$

T1 – Truss Floorbeam Stringer Example

Curb Dead Load on Truss

Curb DL = 85 lb/ft

L0, L6: $18.33' / 2 * 0.085 \text{ k/ft} * 2 \text{ curbs} / 2 \text{ trusses} = 0.78 \text{ kips}$

L1, L2, L3, L4, L5: $18.33' * 0.085 \text{ k/ft} * 2 \text{ curbs} / 2 \text{ trusses} = 1.56 \text{ kips}$

Floorbeam Dead Load on Truss

Floorbeam DL = $221 \text{ lb/ft} * 35 \text{ ft} = 7735 \text{ lb}$

L0, L1, L2, L3, L4, L5, L6: $7.735 \text{ kips} / 2 \text{ trusses} = 3.87 \text{ kips}$

Stringer Dead Load on Truss

Exterior Stringer DL = 57 lb/ft

Interior Stringer DL = 57 lb/ft

L0, L6: $7 \text{ stringers} * 0.057 \text{ kip/ft} * 18.33' / 2 / 2 \text{ trusses} = 1.83 \text{ kips}$

L1, L2, L3, L4, L5: $7 \text{ stringers} * 0.057 \text{ kip/ft} * 18.33' / 2 \text{ trusses} = 3.66 \text{ kips}$

The truss command language description for the truss line is the same as the description for the truss system with the addition of a command to describe the user computed floor system dead loads. The following is the PanelPointLoad command used to describe the floor system dead load acting on the truss. This command comes after the Support command.

PanelPointLoad

L0 DC 0.0 -25.38

L1 DC 0.0 -46.90

L2 DC 0.0 -46.90

L3 DC 0.0 -46.90

L4 DC 0.0 -46.90

L5 DC 0.0 -46.90

L6 DC 0.0 -25.38